

CÚPULA TOURING PARA - TOURING SCREEN FOR - TOURENSCHEIBE FÜR
SUZUKI DL650 V-STROM '17-

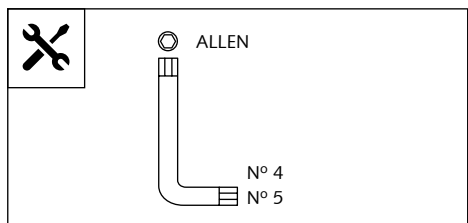

Ref.: 9719



1 persona
1 person

20 min

Fácil - Easy
 Media-Intermediate
 Difícil-Difficult

ID.	PIEZA / PART	DESCRIPCIÓN	DESCRIPTION	QTY.	REF.:
1		Pantalla	Windshield	1	9719F/H/HVS/WMB
2		Soporte derecho R·	R· Right support	1	SOPOR-2P-5-9719
3		Soporte derecho L·	L· Left support	1	SOPOR-2P-5-9719
4		Tornillo M6x12 Ø11 ISO 7380	M6x12 Ø11 screw ISO 7380	4	TORNIAI7380-205
5		Casquillo con valona	Spacer with flange	4	CASQUI-1A---324
6		Tornillo M6x16 Ø14 ISO 7380	M6x16 Ø14 screw ISO 7380	4	TORNI-I7380-403

CÚPULA TOURING PARA - TOURING SCREEN FOR - TOURENSCHEIBE FÜR
SUZUKI DL650 V-STROM '17-

INSTRUCCIONES DE MONTAJE - MOUNTING INSTRUCTIONS - MONTAGEANLEITUNG

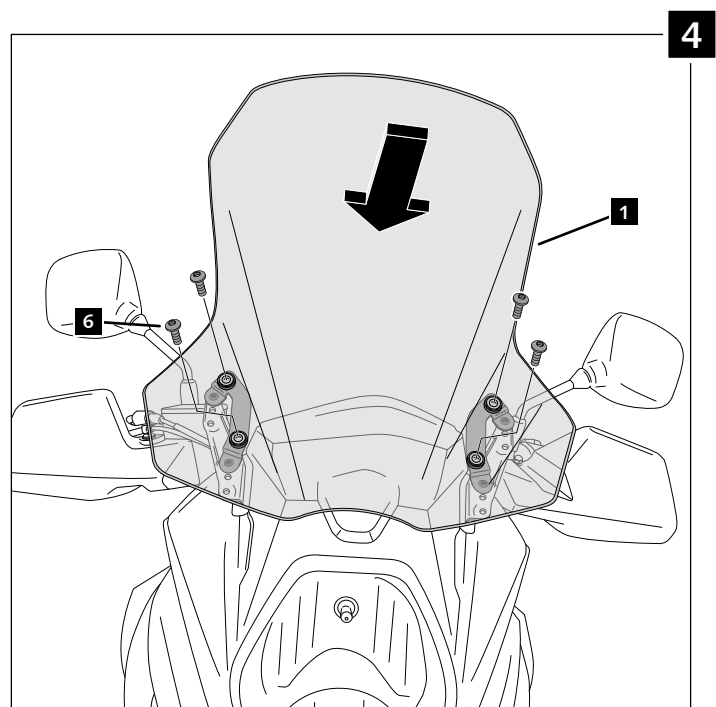
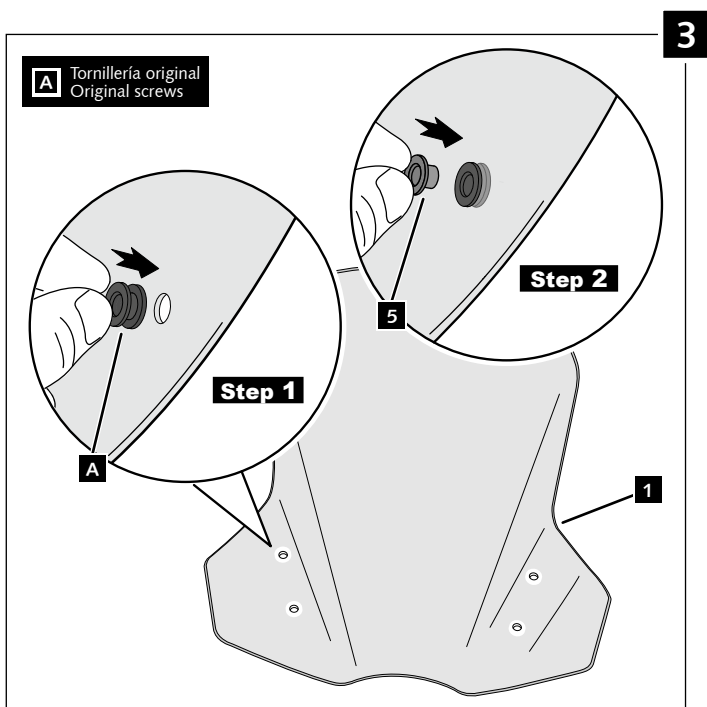
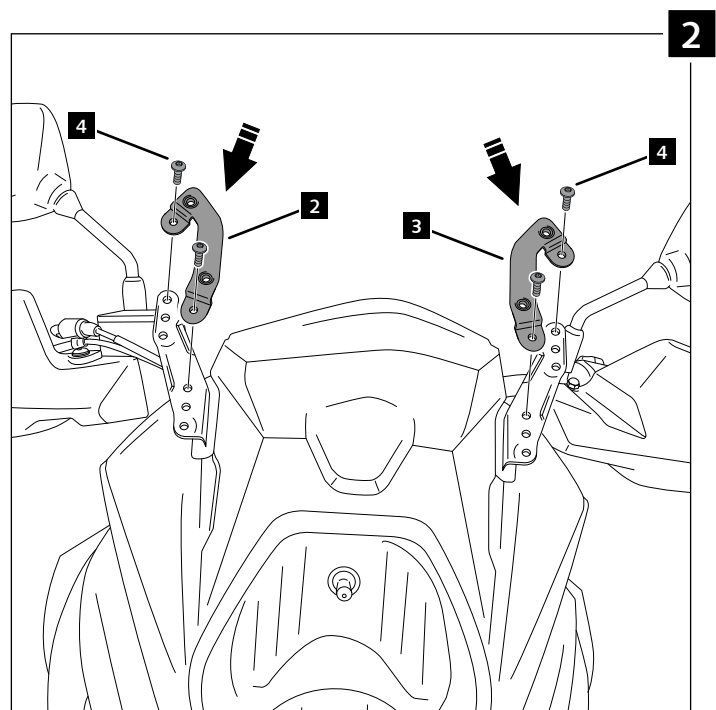
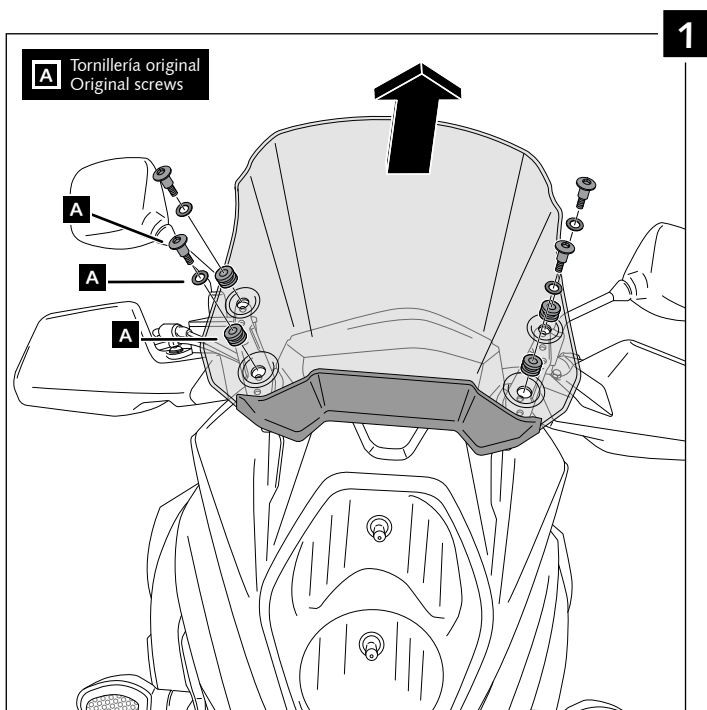

VISERA MULTIREGULABLE MULTI-ADJUSTABLE VISOR

CÚPULA TIPO
TYPE WINDSCREEN **A**



CÚPULA TIPO
TYPE WINDSCREEN **B**



CÚPULA TIPO
TYPE WINDSCREEN **C**



Ref.: 6007

Ref.: 5852

Ref.: 5853

Ahumado/Smoke

Transparente/Clear

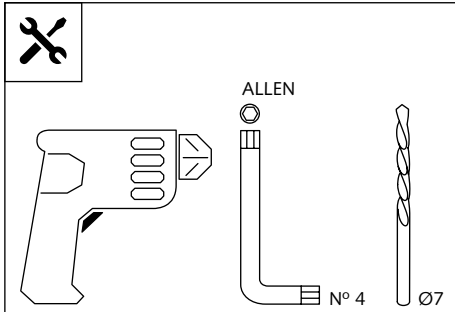

1 persona
1 person



15 min

Fácil - Easy

Media-Intermediate

Difícil-Difficult

Nota/Note:

Si la visera se suministra con la cúpula Puig, no será necesario realizar los agujeros por que ya vienen incorporados.

If the visor is supplied along with the windscreen, the windscreen will come factory-drilled so no drilling is necessary.

ID.	PIEZA / PART	DESCRIPCIÓN	DESCRIPTION	QTY.
1		Visera	Visor	1
2		Plantilla	Template	1
3		Mecanismo multiregulable	Multi-adjustable mechanism	2
4		Tapeta	Cap	4
5		Tornillo rosca plástico M6x12	Plastic thread fastener M6x12	8

VISERA MULTIREGULABLE MULTI-ADJUSTABLE VISOR

INSTRUCCIONES DE MONTAJE - MOUNTING INSTRUCTIONS - MONTAGEANLEITUNG

TIPO/TYPER A - TIPO/TYPER A - TIPO/TYPER A

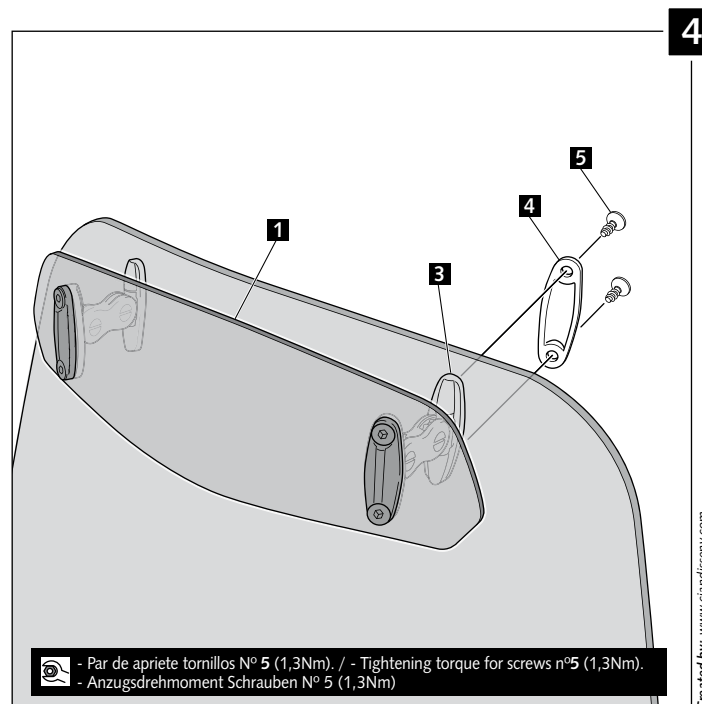
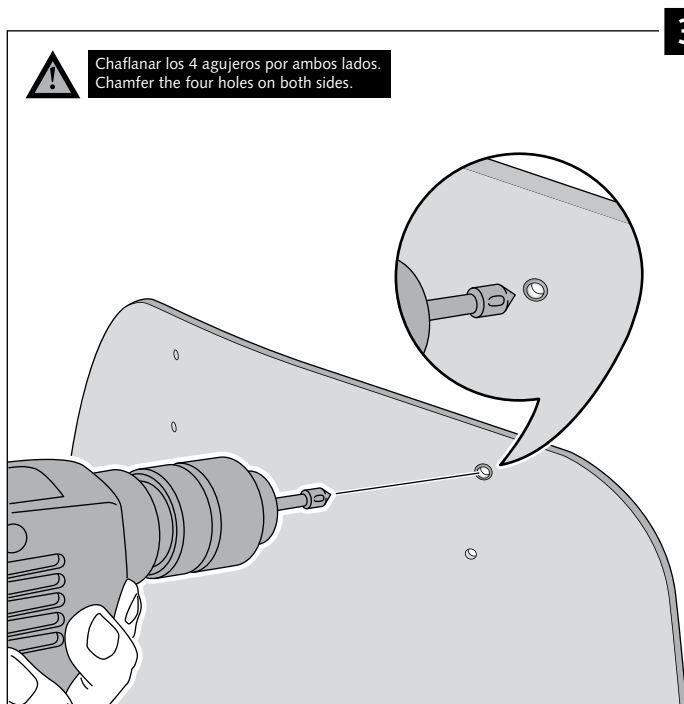
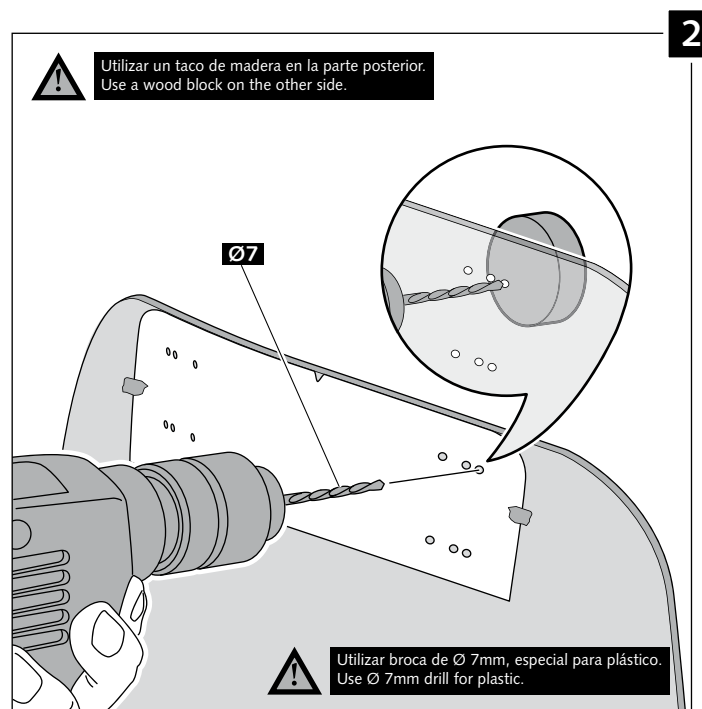
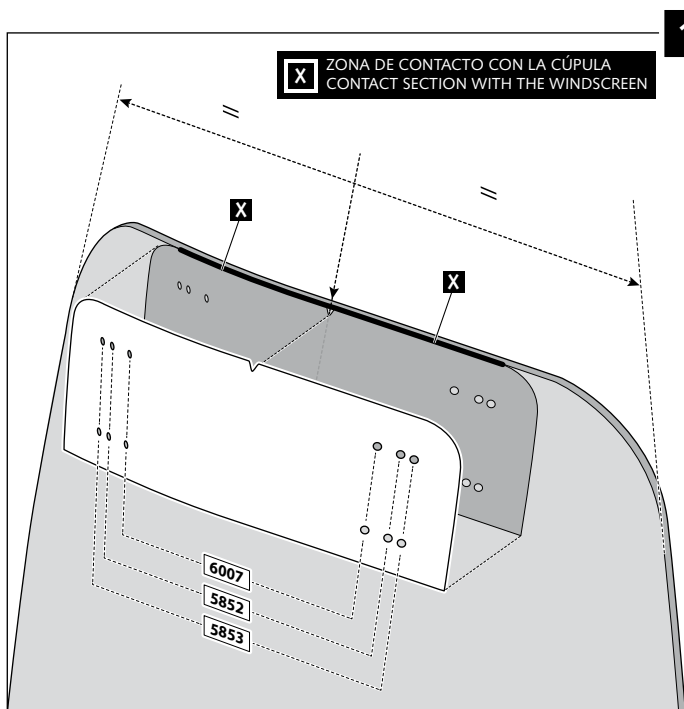

VISERA MULTIREGULABLE MULTI-ADJUSTABLE VISOR

INSTRUCCIONES DE MONTAJE - MOUNTING INSTRUCTIONS - MONTAGEANLEITUNG

TIPO/TYPE B - TIPO/TYPE B - TIPO/TYPE B

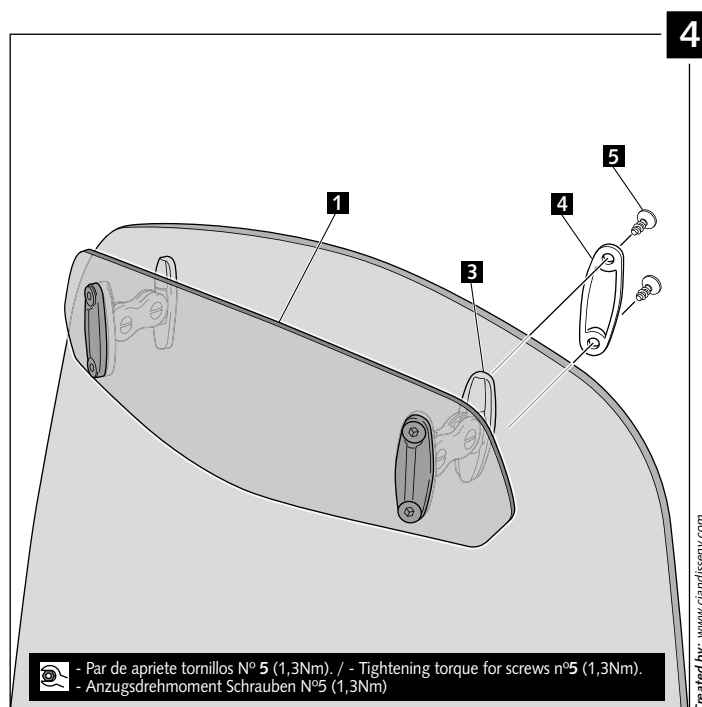
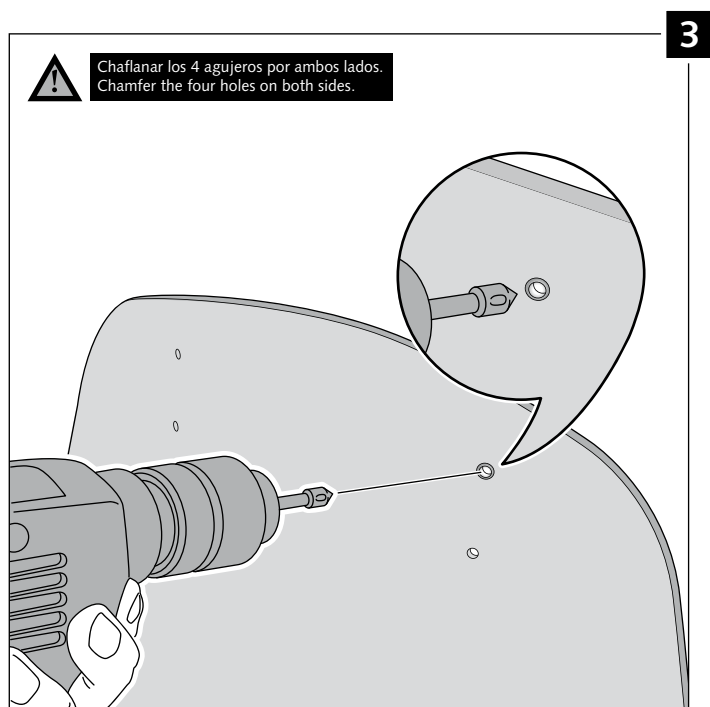
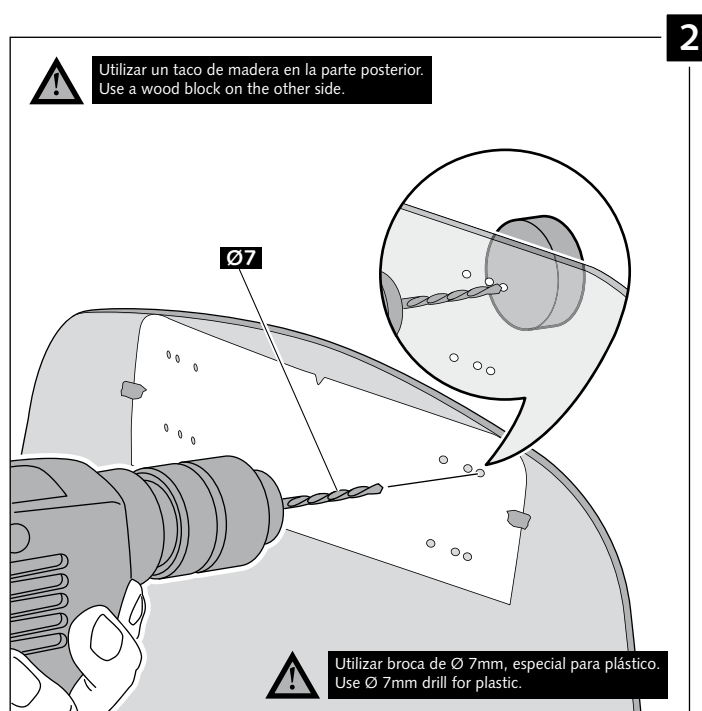
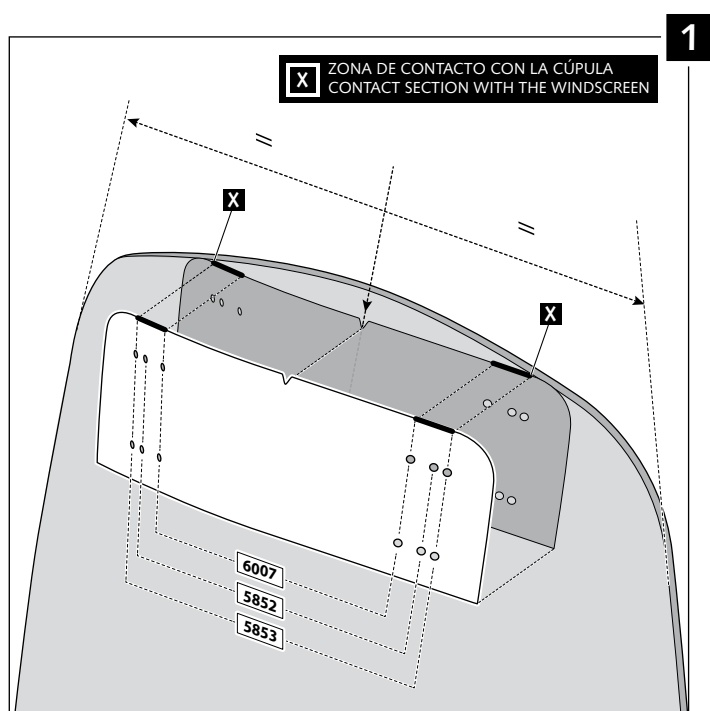

VISERA MULTIREGULABLE MULTI-ADJUSTABLE VISOR

INSTRUCCIONES DE MONTAJE - MOUNTING INSTRUCTIONS - MONTAGEANLEITUNG

TIPO/TYPER C - TIPO/TYPER C - TIPO/TYPER C

