

MOTOPLASTIC, S.A.

Molí de la sal, 1 - 08403 Granollers (Barcelona) SPAIN

Tel. 34 93 849 06 33 - Fax 34 93 849 09 88

info@puig.tv - info@puigusa.com







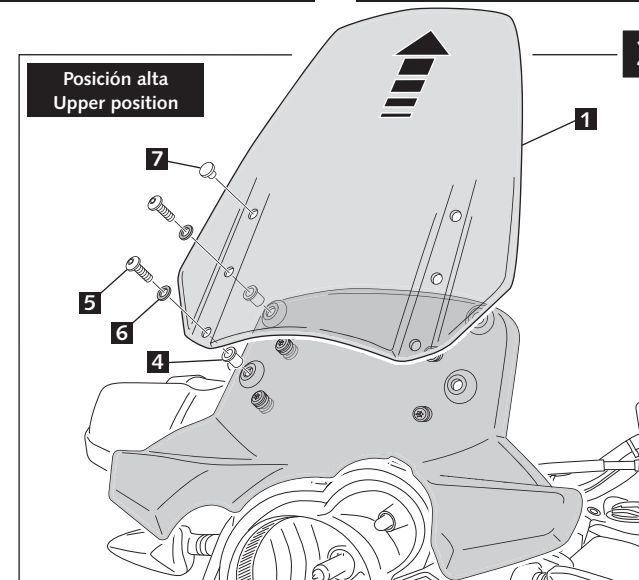
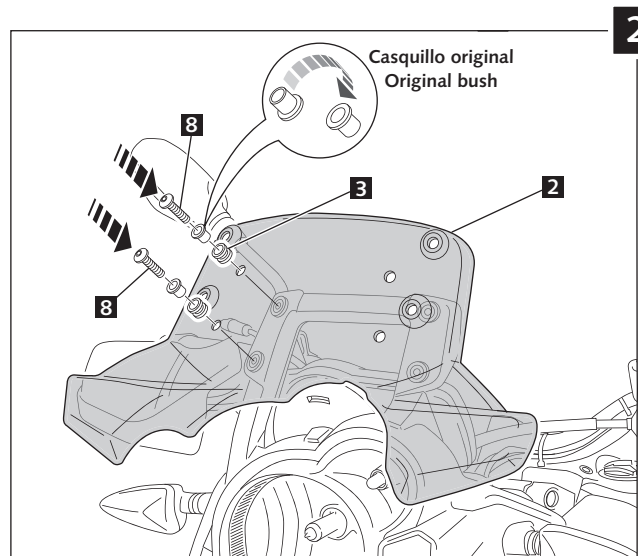
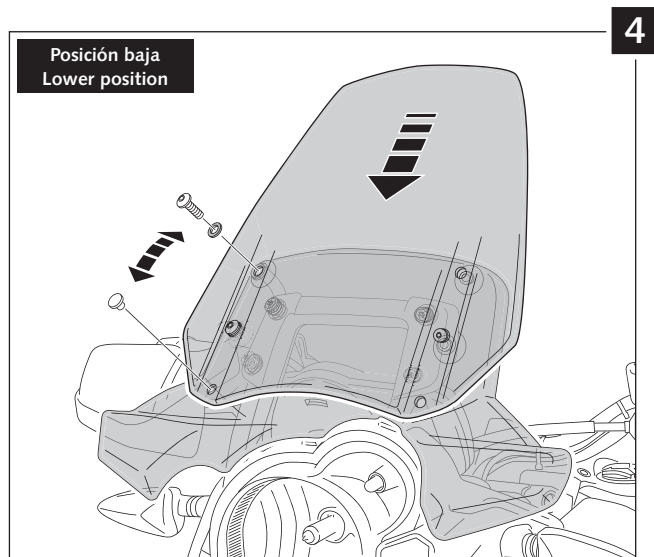
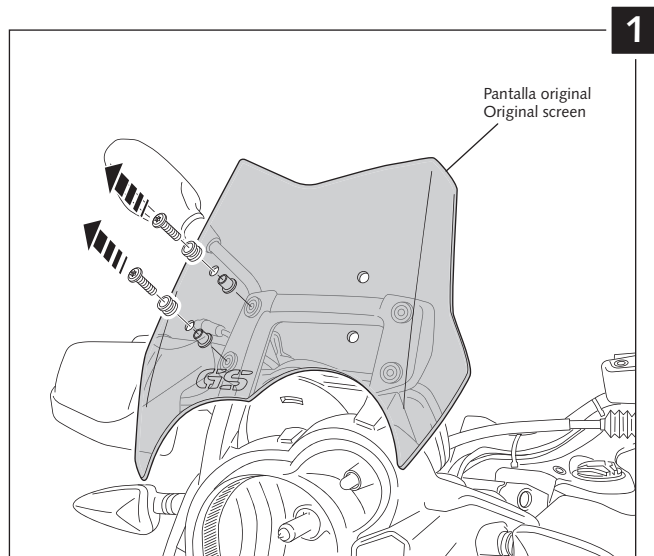

www.puig.tv - www.puigusa.com

INSTRUCCIONES DE MONTAJE - MOUNTING INSTRUCTIONS

CÚPULA ADAPTABLE A - SCREEN ADAPTABLE TO BMW G 650 GS 2011-2014

Ref.: 5649



ID.	DESCRIPCIÓN	DESCRIPTION	QTY.
1	 Pantalla móvil	Mobile screen	1
2	 Pantalla inferior	Lower screen	1
3	 Silemblock	Silemblock	4
4	 Silemblock M6	M6 well nut	4
5	 Tornillo Allen M6x15 ISO 7380	M6x15 ISO 7380 Allen screw	4
6	 Arandela nylon Ø6	Ø6 nylon washer	4
7	 Tapón plástico Ø7	Ø7 plastic plug	2
8	 Tornillo Allen M5x20 ISO 7380	M5x20 ISO 7380 Allen screw	4