

MOTOPLASTIC, S.A.

Molí de la sal, 1 - 08403 Granollers (Barcelona) SPAIN

Tel. 34 93 849 06 33 - Fax 34 93 849 09 88

info@puig.tv









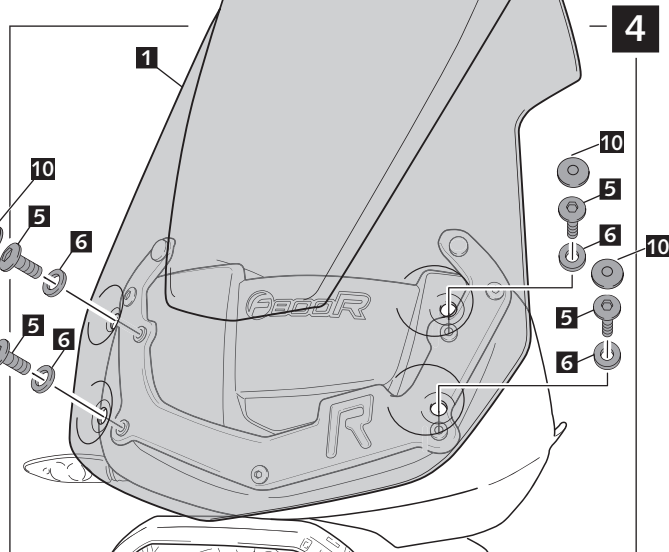
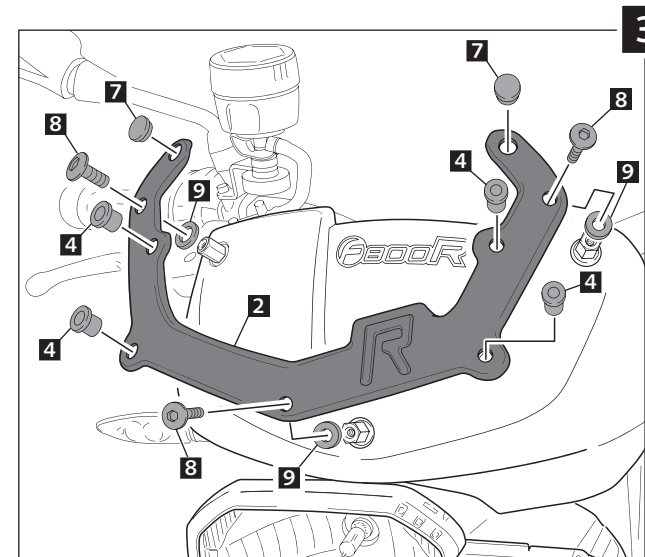
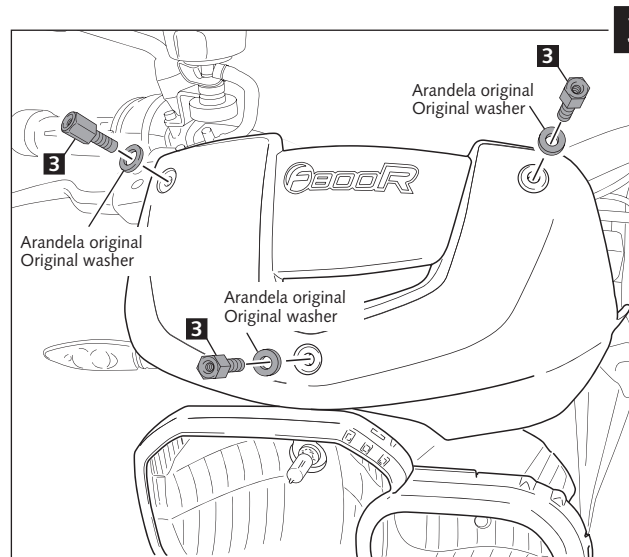
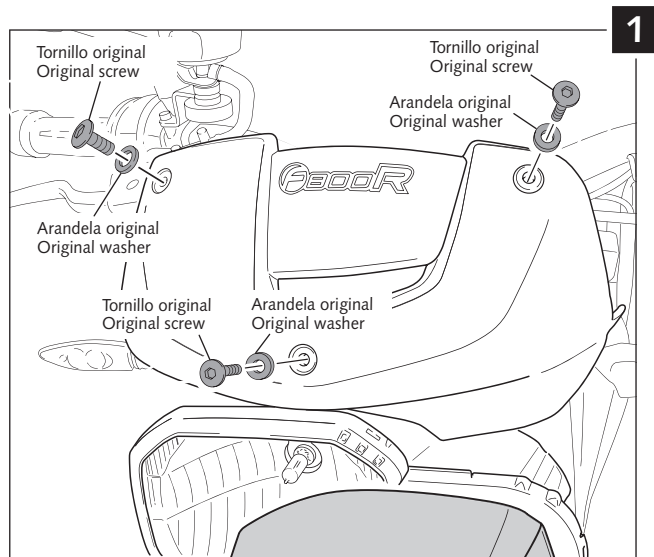

www.puig.tv

CARENABRÍS ADAPTABLE A - WINDSHIELD ADAPTABLE A - WINDSCHUTZSCHEIBE FÜR

BMW F800 R '09 - '11

Ref.: 5051



ID.	DESCRIPCIÓN	DESCRIPTION	QTY.
1	 Pantalla	Screen	1
2	 Soporte metálico	Metal support	1
3	 Tornillo especial M5x17 + rosca interior M5x10	Special screw M5x17 + interior thread M5x10	3
4	 Tuerca M5 silemblock	M5 silemblock nut	4
5	 Tornillo Allen M5x16 ISO 7380	M5x16 ISO 7380 allen screw	4
6	 Arandela nylon Ø5xØ11x1	Ø5xØ11x1 nylon washer	4
7	 Tapón plástico Ø10	Ø10 Plastic plug	2
8	 Tornillo Allen M5x10 ISO 7380	M5x10 ISO 7380 allen screw	3
9	 Arandela de goma Øext.13 x Øint.5x4	Øouter 13 x Øinner 5x4 washer	3
10	 Tapón tornillo M5 ISO 7380	M5 ISO 7380 screw cap	4

MOTOPLASTIC, S.A.

Molí de la sal, 1 - 08403 Granollers (Barcelona) SPAIN

Tel. 34 93 849 06 33 - Fax 34 93 849 09 88

info@puig.tv

www.puig.tv

