

HONDA CRF1000L AFRICA TWIN '16-

M O U N T I N G I N S T R U C T I O N S

VIDEO

REF 3484

REAR MUDGUARD



1 Person



40 min



MEDIUM









ALLEN
Nº 4
Nº 5

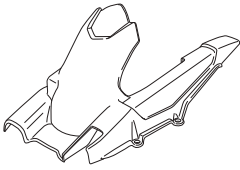
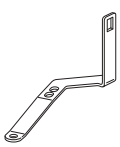

PHILLIPS
SCREWDRIVER



ID	PIEZA/PART	DESCRIPCIÓN	DESCRIPTION	QTY	REF
1		Guardabarros	Mudguard	1	3484J/CM3
2		Soporte	Support	1	SOPORIP4-3484
3		Tornillo Allen M6x20 Ø14 ISO7380	M6x20 Ø14 ISO7380 Allen screw	4	TORNI-I7380-404
4		Casquillo con valona Ø15x Ø9 x7,5	Ø15x Ø9 x7,5 bush with flange	4	CASQUI-1A---324
5		Silentblock Ø18x Ø9 xØ11 x7,5	Ø18x Ø9 xØ11 x7,5 silentblock	4	SILENBGONE--064
6		Tuerca enjaulada de aluminio M6 (se suministra montada)	Luck nut M6 (supplied mounted)	1	TUERCAJFM6-716
7		Tapón tornillo M6 ISO 7380	M6 ISO 7380 Screw cap	4	TAPON-----86

HONDA CRF1000L AFRICA TWIN '16-

EXPLOTING

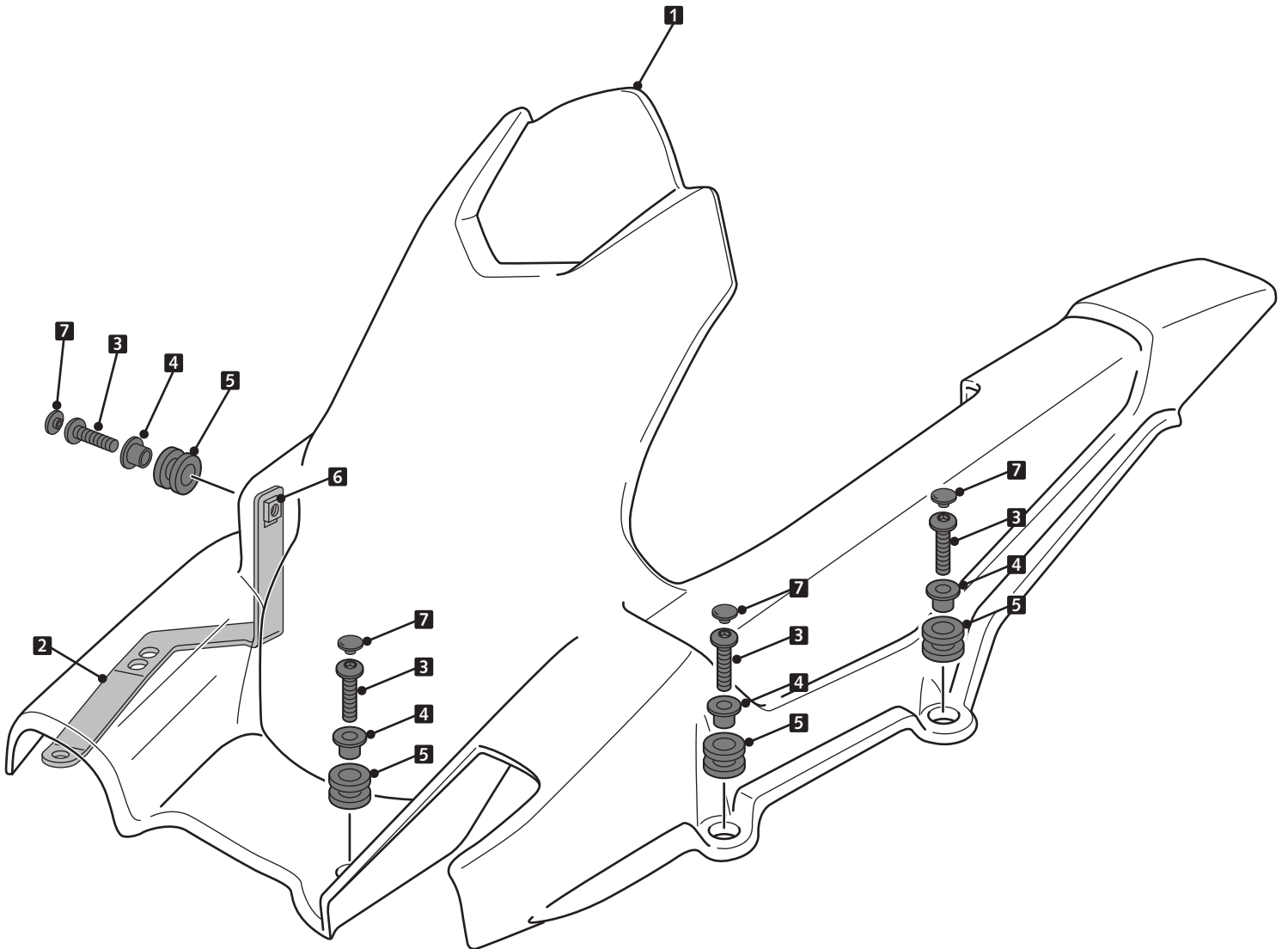

- PARA NEUMÁTICOS OFF-ROAD, CONSULTAR COMPATIBILIDAD EN info@puig.tv
- FOR OFF-ROAD TIRES, PLEASE CHECK SUITABILITY AT info@puig.tv OR info@puigusa.com
- OFF-ROAD Reifen Verträglichkeit zu prüfen, info@puig.tv