

KAWASAKI ZX-6R '24-

M O U N T I N G I N S T R U C T I O N S

VIDEO

REF 22660

FRONTAL SPOILERS GP



1 Person



40 min



EASY



ALLEN

FIX

Nº 3
Nº 4
Nº 5

Nº 8
Nº 10

ID.	PIEZA/PART	DESCRIPCIÓN	DESCRIPTION	QTY.	REF.:
1		Alerón frontal GP	Frontal spoiler GP	1	22660J/N/CM3
2		Soporte izquierdo (L)	Left support	1	SOPOR3P3-L22660
3		Soporte derecho (R)	Right support	1	SOPOR3P3-R22660
4		Soporte central	Central support	1	SOPOR3P3-C22660
5		Casquillo Ø9xØ6,5x6,5mm	Ø9xØ6,5x6,5mm arrowhead	2	CASQUI-----0046
6		Tornillo Allen M6x20 Ø14 ISO7380	M6x20 Ø14 ISO7380 allen screw	2	TORNI-I7380-404
7		Tuerca de clip M6 (Negra)	M6 clip nut	2	TUERCA-TRT-M6--
8		Casquillo Ø9xØ6,5x4mm	Ø9xØ6,5x4mm arrowhead	2	CASQUI-M----606
9		Tornillo especial M6x12 Long Hexagonal 34 (Rosca int M5x15)	Tornillo especial M6x12 Long Hexagonal 34 (Thread int M5x15)	2	TORNI-E-----762
10		Tornillo allen M5x12 Ø11 ISO 7380	M5x12 Ø11 ISO 7380 allen screw	2	TORNI-AI----520
11		Arandela M8 Schorr NF25511	M8 Schorr NF25511 washer	2	ARAND-----803
12		Tope de goma Ø11xØ5,5x7mm	Ø11xØ5,5x7mm Bumper foot	2	TOPEGOMA--22384
13		Tornillo Allen M5x12 DIN7991	M5x12 DIN7991 Allen screw	4	TORNI-D7991-611
14		Arandela de goma Ø4,5xØ11x2mm	Ø4,5xØ11x2mm Rubber washer	4	ARAND-EPDM--722
15		Tapón tornillo M5 DIN7991	M5 DIN7991 screw cap	4	TAPON-----92

KAWASAKI ZX-6R '24-

INSTRUCCIONES DE MONTAJE - MOUNTING INSTRUCTIONS - MONTAGEANLEITUNG

1

Se muestra el montaje del lado izquierdo a modo de ejemplo, realizar los mismos pasos para el montaje del lado derecho.
The left side assembly is shown as an example, so the same steps can be performed for the right side assembly.

DISASSEMBLY
DESMONTAJE

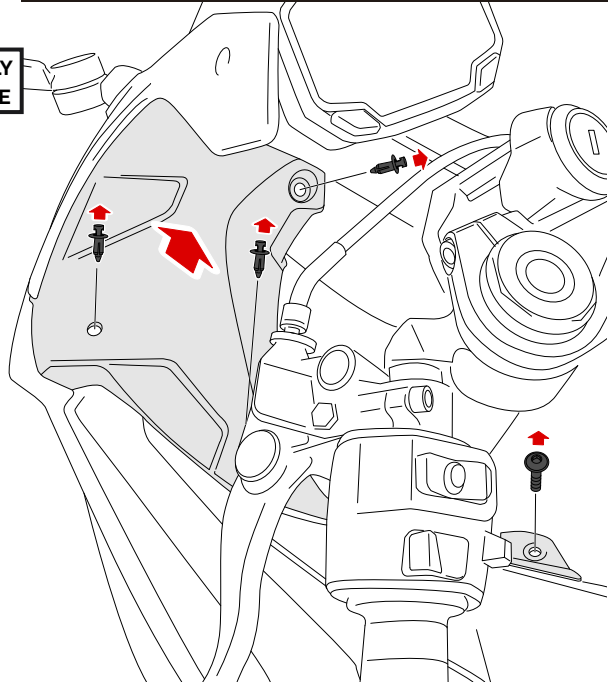

2

DISASSEMBLY
DESMONTAJE

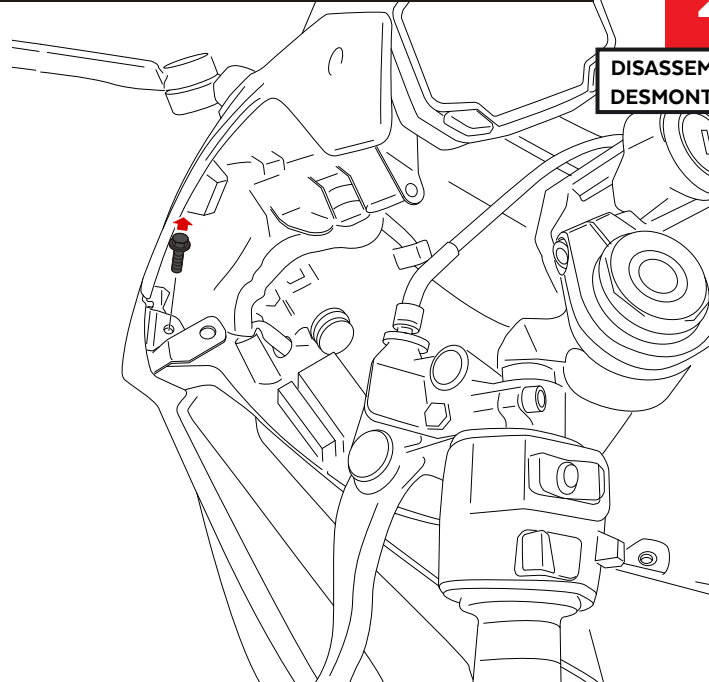

3

DISASSEMBLY
DESMONTAJE

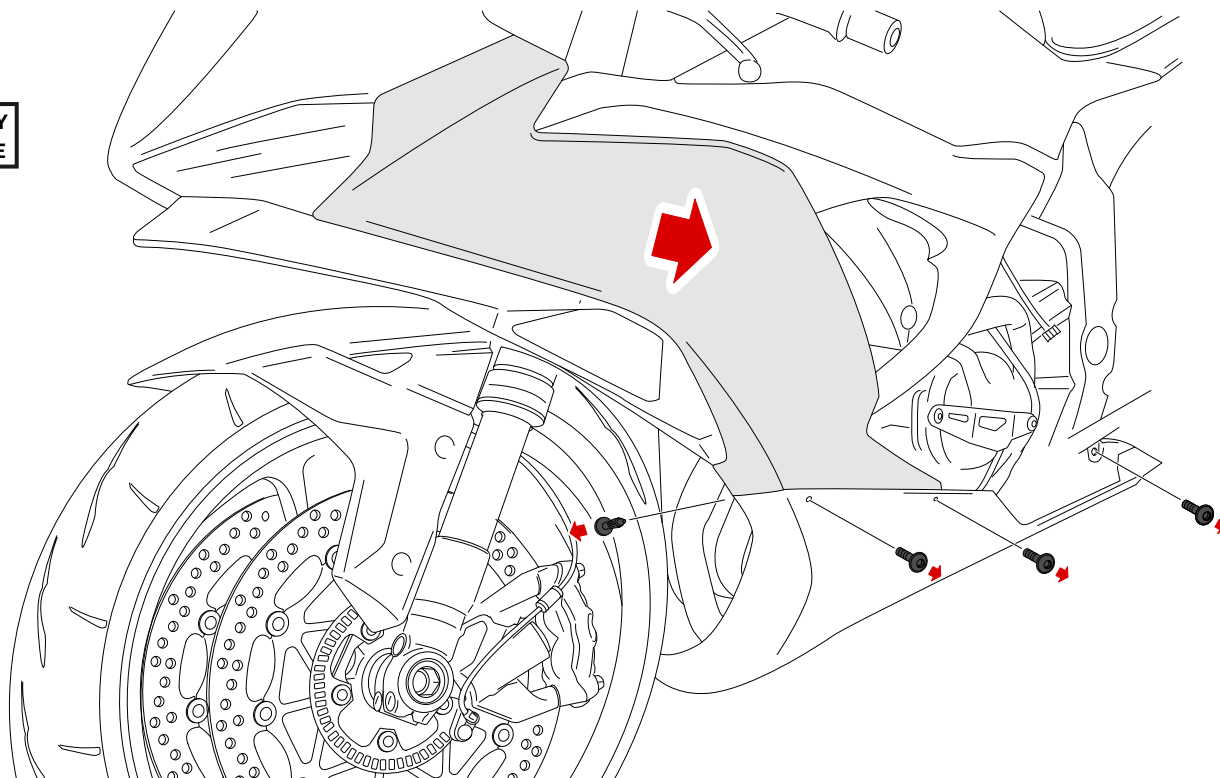

KAWASAKI ZX-6R '24-

INSTRUCCIONES DE MONTAJE - MOUNTING INSTRUCTIONS - MONTAGEANLEITUNG

4

**DISASSEMBLY
DESMONTAJE**

Se muestra el montaje del lado izquierdo a modo de ejemplo, realizar los mismos pasos para el montaje del lado derecho.
The left side assembly is shown as an example, so the same steps can be performed for the right side assembly.

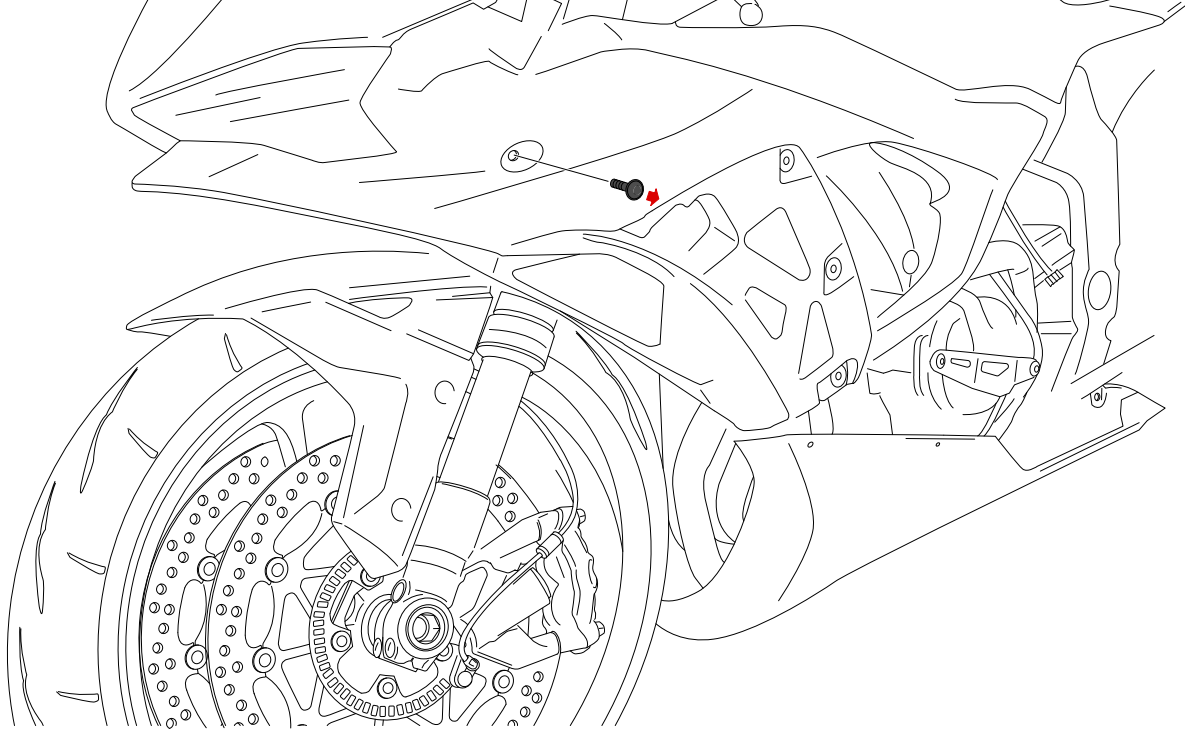

5

**ASSEMBLY
MONTAJE**

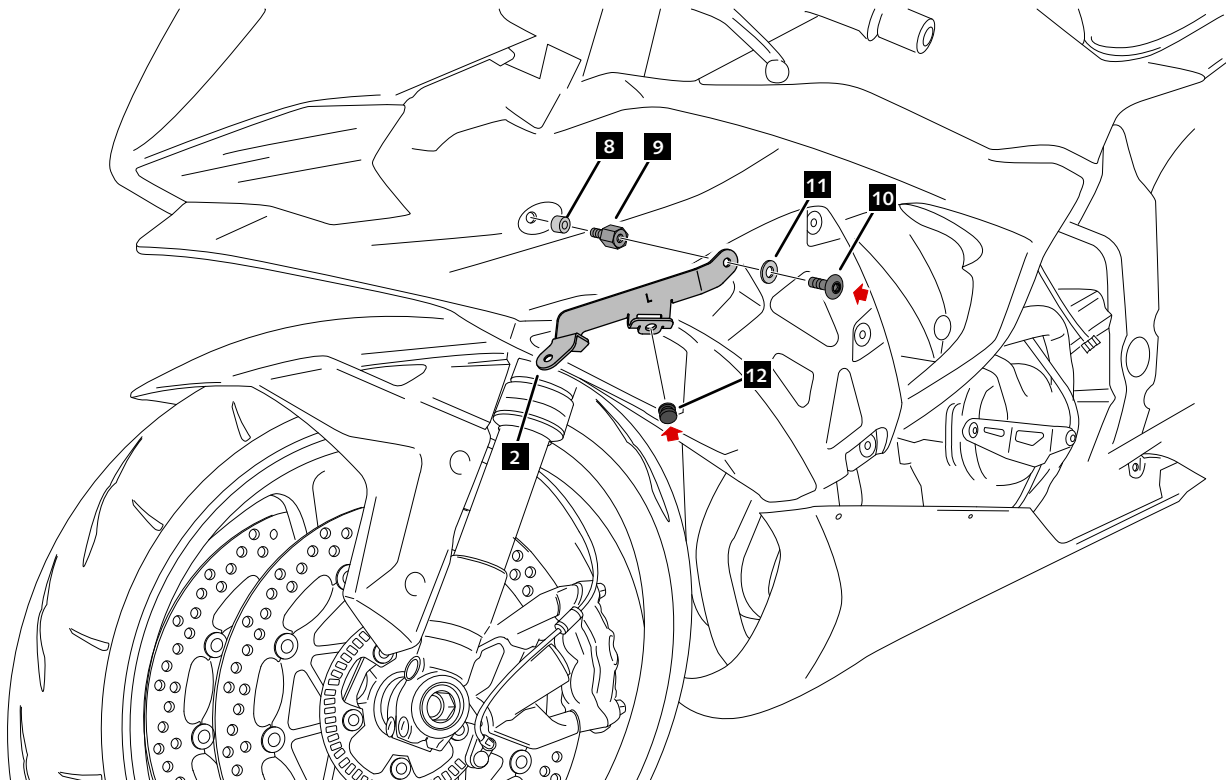

KAWASAKI ZX-6R '24-

INSTRUCCIONES DE MONTAJE - MOUNTING INSTRUCTIONS - MONTAGEANLEITUNG

Se muestra el montaje del lado izquierdo a modo de ejemplo, realizar los mismos pasos para el montaje del lado derecho.
The left side assembly is shown as an example, so the same steps can be performed for the right side assembly.

6

ASSEMBLY
MONTAJE

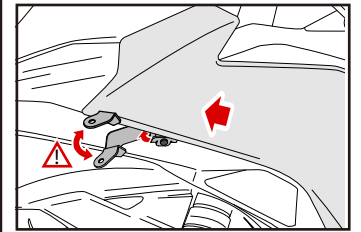
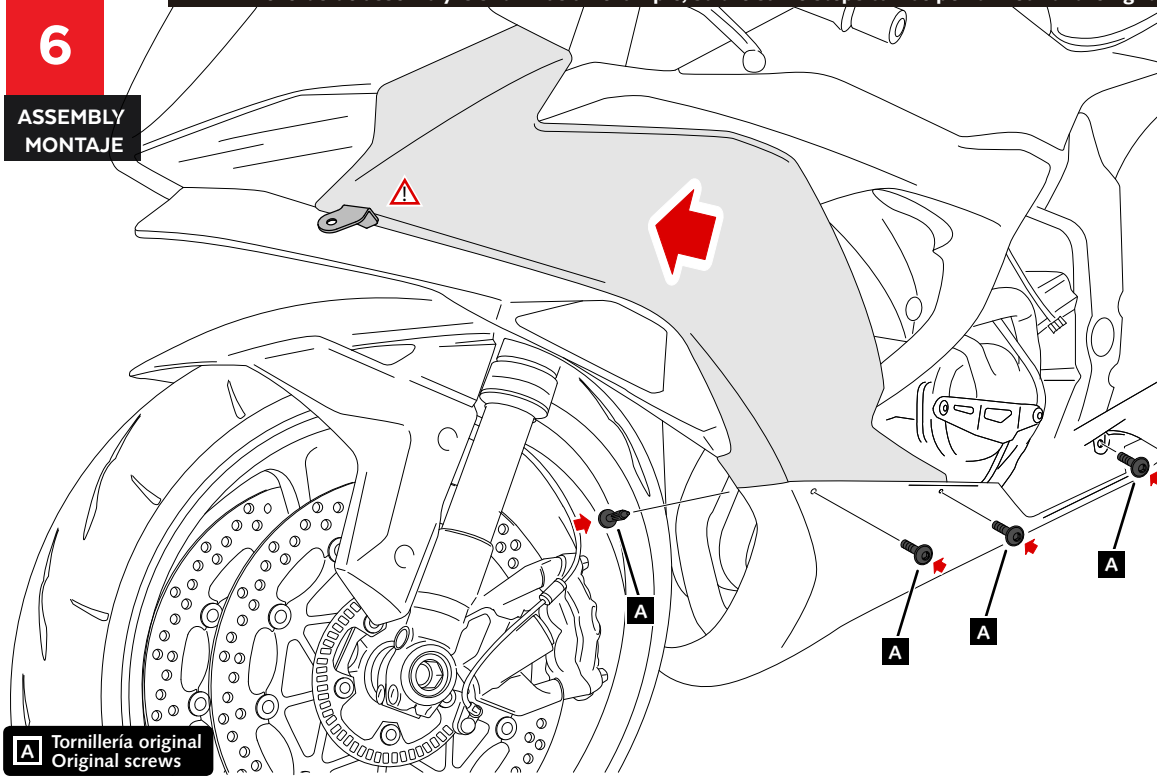

PARA FACILITAR EL MONTAJE,
ROTAR UN POCO EL SOPORTE
COMO INDICA LA IMAGEN.
UNA VEZ POSICIONADA LA
TAPA LATERAL, VOLVER A
ROTAR EL SOPORTE
POSICIONANDO EL TOPE DE GOMA
AL INTERIOR DE LA TAPA

TO FACILITATE ASSEMBLY,
ROTATE THE SUPPORT SLIGHTLY
AS SHOWN IN THE IMAGE.
ONCE THE SIDE COVER IS
POSITIONED, ROTATE THE SUPPORT
AGAIN, POSITIONING THE ID12
BUMPER FOOT INSIDE THE COVER.

A Tornillería original
Original screws

7

ASSEMBLY
MONTAJE

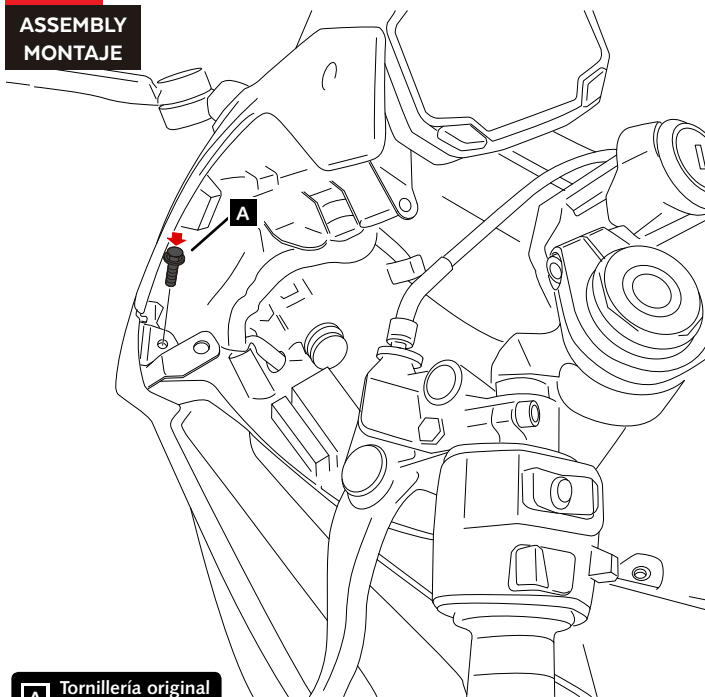

A Tornillería original
Original screws

8

ASSEMBLY
MONTAJE

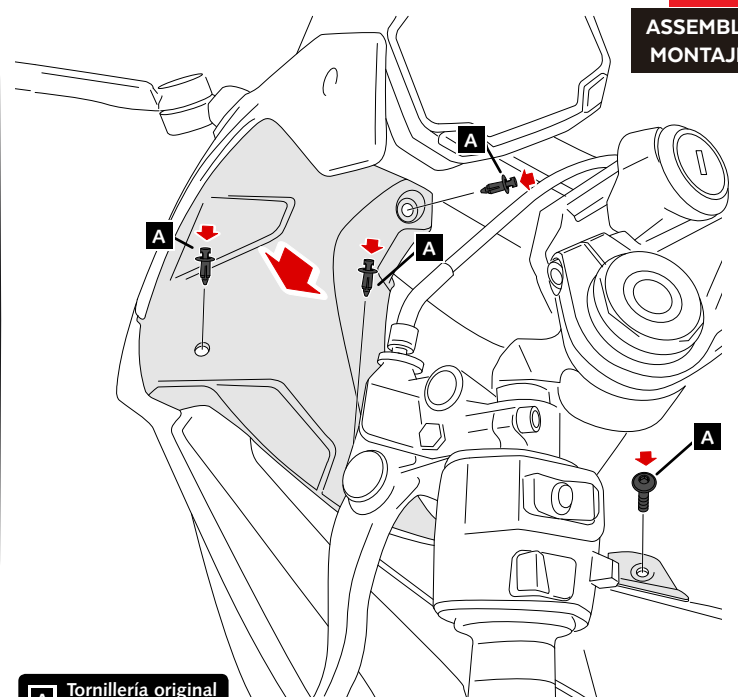

A Tornillería original
Original screws

KAWASAKI ZX-6R '24-

INSTRUCCIONES DE MONTAJE - MOUNTING INSTRUCTIONS - MONTAGEANLEITUNG

9

ASSEMBLY
MONTAJE

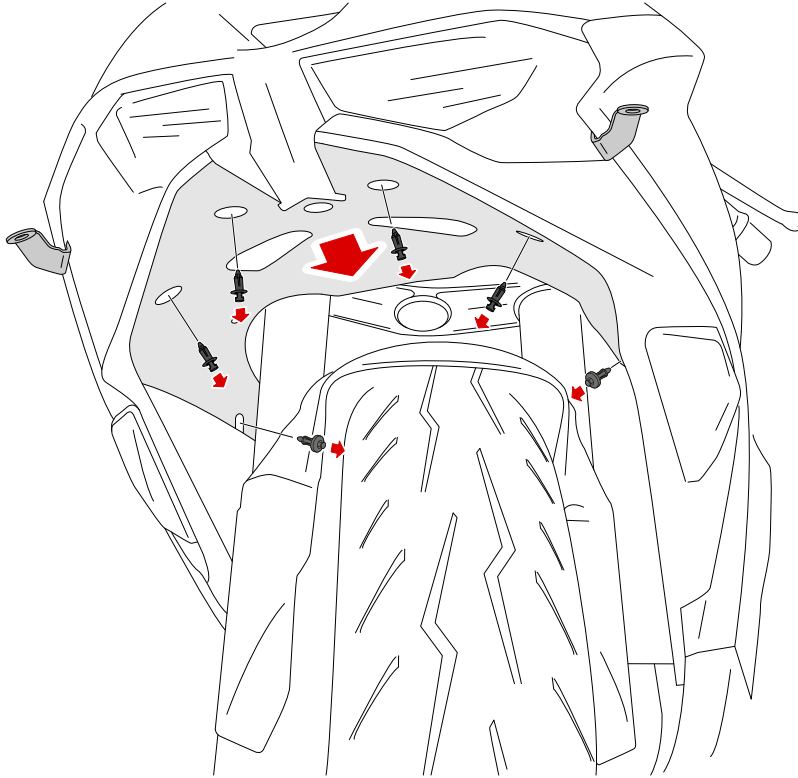

10

ASSEMBLY
MONTAJE

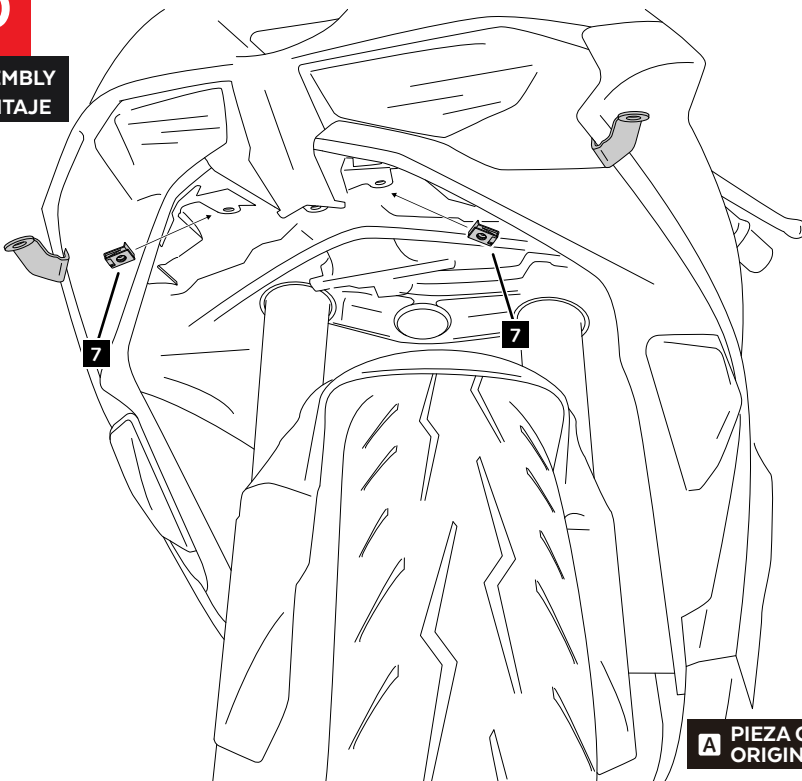

A PIEZA ORIGINAL
ORIGINAL PART

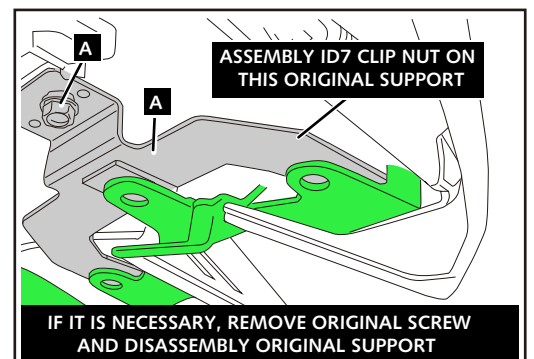

IF IT IS NECESSARY, REMOVE ORIGINAL SCREW AND DISASSEMBLY ORIGINAL SUPPORT

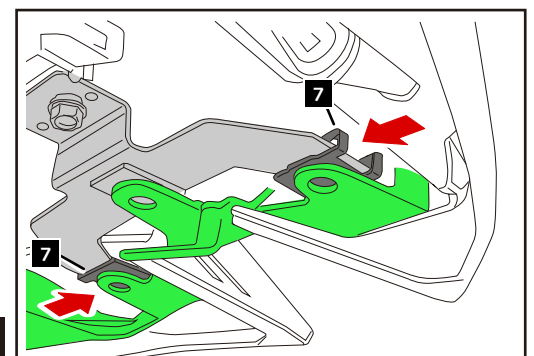

KAWASAKI ZX-6R '24-

INSTRUCCIONES DE MONTAJE - MOUNTING INSTRUCTIONS - MONTAGEANLEITUNG

11

ASSEMBLY
MONTAJE

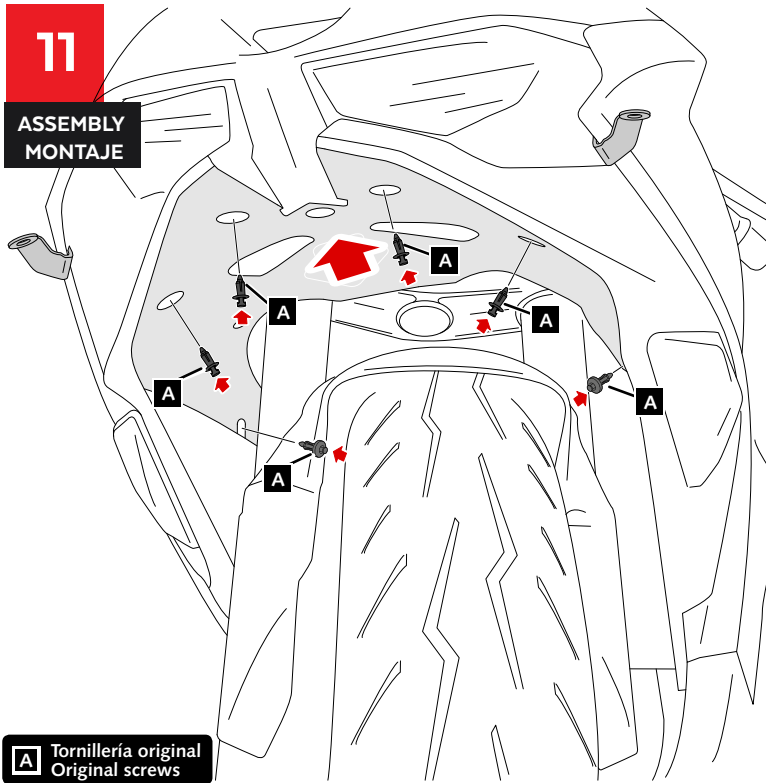

12

ASSEMBLY
MONTAJE

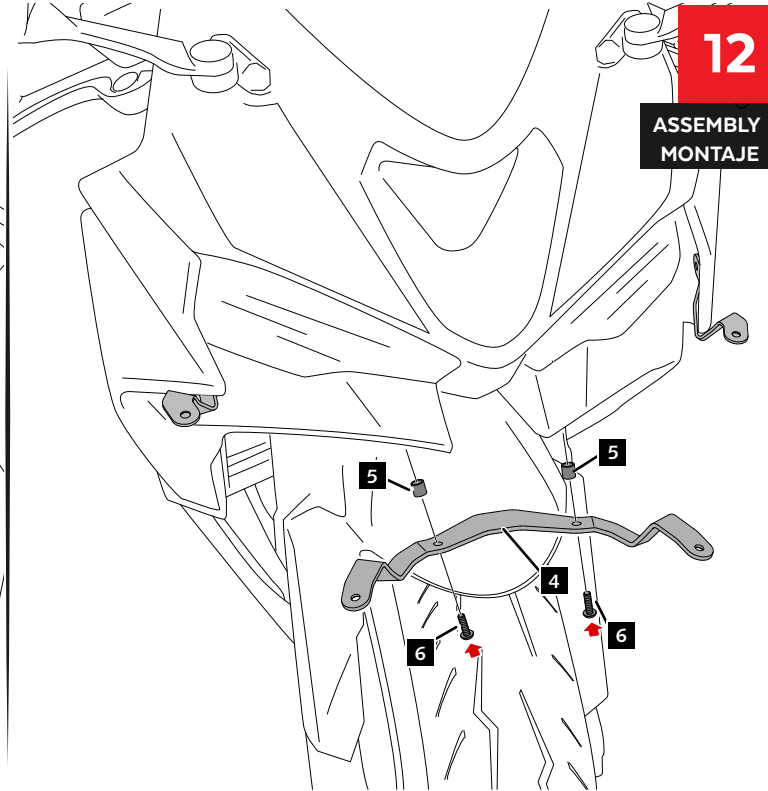

13

ASSEMBLY
MONTAJE

