

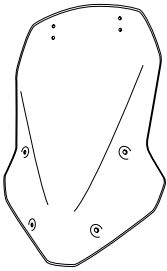

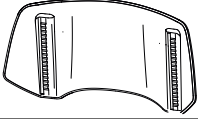

TOURING & TOURING PLUS SCREENS WITH VISOR

M O U N T I N G I N S T R U C T I O N S

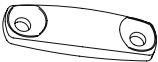

ID.	PIEZA/PART	DESCRIPCIÓN	DESCRIPTION	QTY.	REF.:
1		Cúpula Touring, Touring Plus	Touring, Touring Plus screen	1	SEE WEB SITE
2		Visera de policarbonato antirayadas	Antiscratch polycarbonate Visor	1	20765H/WM3
3		Mecanismo Izquierdo	Left Mechanism	1	SEE EXPLOTING PAGE 2
4		Mecanismo derecho	Right Mechanism	1	SEE EXPLOTING PAGE 2
5		Tapa	Cover	2	TAPAFIX-VISOR--
6		Tornillo Allen ST 6,3 x14mm	ST 6,3 x14mm allen screw	4	TOZ-N00M60000258
7		Tapón tonillo M6 DIN7991	M6 DIN7991 screw cap	4	TAPON-----81

TOURING & TOURING PLUS SCREENS WITH VISOR

INSTRUCCIONES DE MONTAJE - MOUNTING INSTRUCTIONS - MONTAGEANLEITUNG

1

VISOR
EXPLOTING

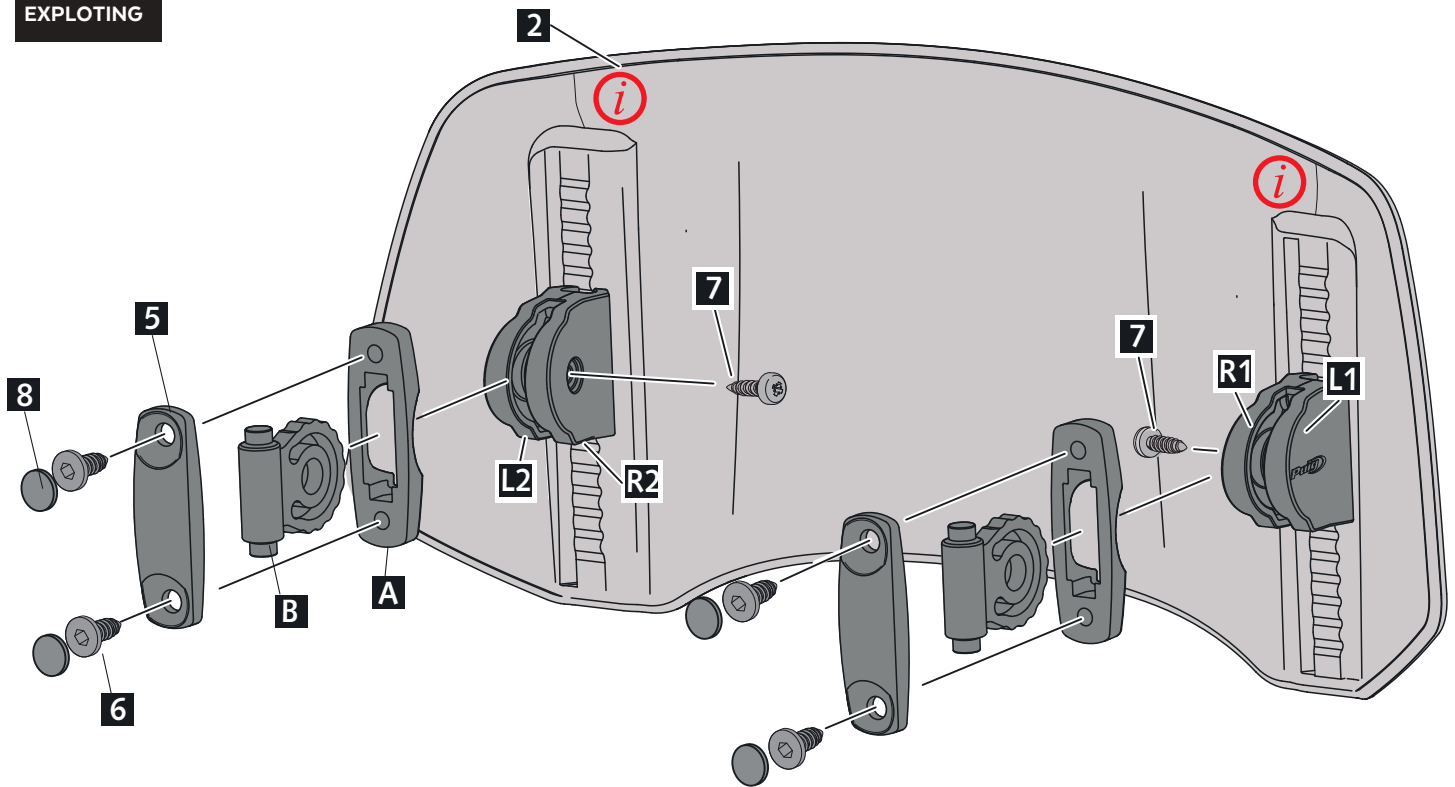

i LINEA DE PARTICIÓN DEL MOLDE DE INYECCIÓN.
PARTING LINE OF THE INJECTION MOLD **i**

ID	PIEZA/PART	DESCRIPCIÓN	DESCRIPTION	QTY	REF
A		Tapa pieza eje	Axle part cover	2	TAPAEJE-VISOR--
B		Pieza eje	Axle part	2	EJE-FIX-VISOR--
L2		Tapa 2 Logo	Logo cover 2	1	TAPALAT-VISORL2
R2		Tapa 2 Tornillo	Screw cover 2	1	TAPALAT-VISORR2
L1		Tapa 1 Logo	Logo cover 1	1	TAPALAT-VISORL1
R1		Tapa 1 Tornillo	Screw cover 1	1	TAPALAT-VISORR1
5		Tapa cúpula	screen cover	2	TAPAFIX-VISOR--
6		Tornillo allen S.T. 6,3 x14	S.T. 6,3 x14 Allen screw	4	TOZN00M60000258
7		Tornillo Ø3,5x9,5 DIN7981 C (negro)	Ø3,5x9.5 DIN7981 C screw (black)	2	TORNI-D7981-907
8		Tapón tornillo M6	M6 Screw cap	4	TAPON-----81

TOURING & TOURING PLUS SCREENS WITH VISOR

INSTRUCCIONES DE MONTAJE - MOUNTING INSTRUCTIONS - MONTAGEANLEITUNG

2

ASSEMBLY
MONTAJE

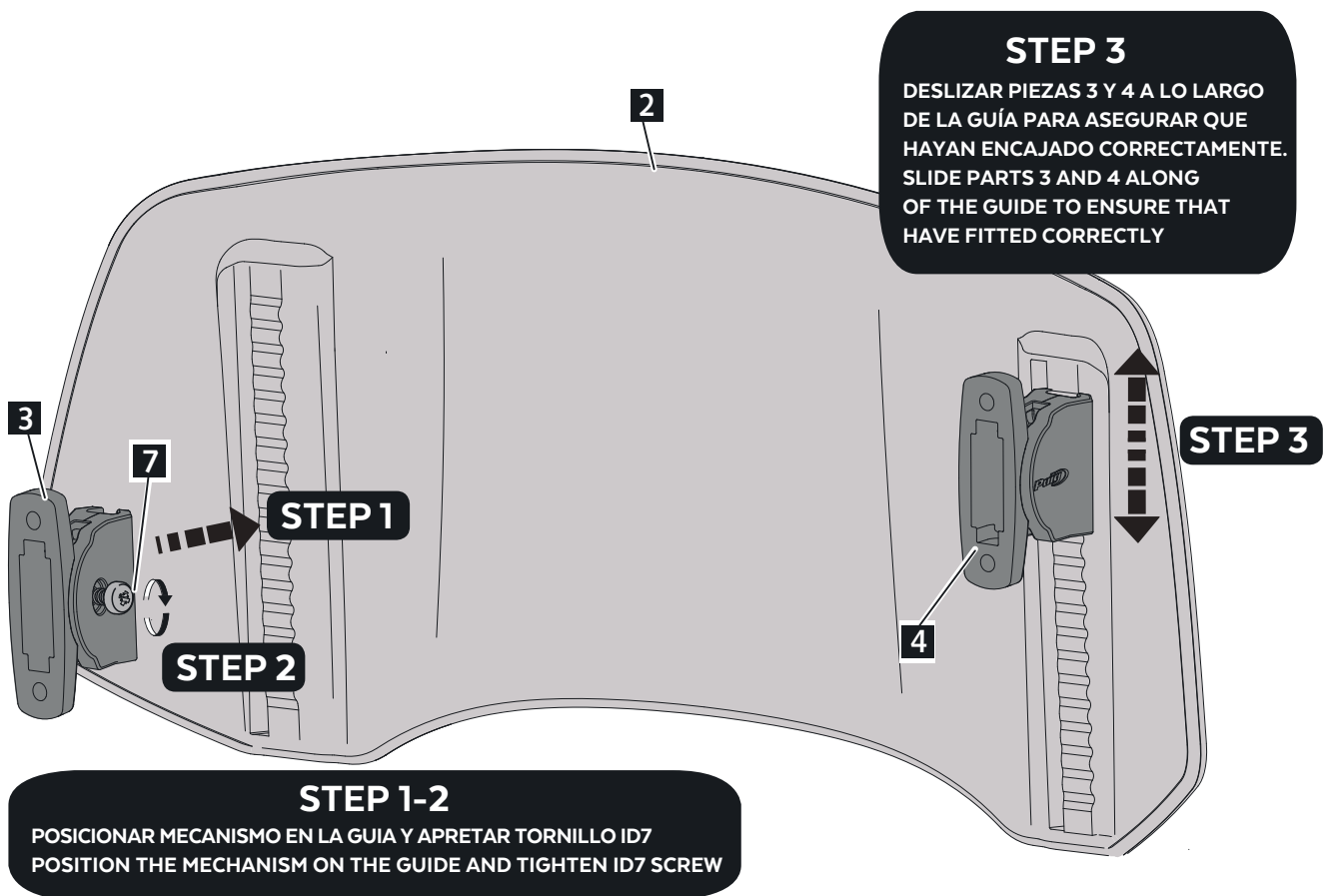

PAR APRIETE TORNILLO ID7 1 Nm
TIGHTENING TORQUE FOR ID7 SCREW 1 Nm

TOURING & TOURING PLUS SCREEN WITH VISOR

INSTRUCCIONES DE MONTAJE - MOUNTING INSTRUCTIONS - MONTAGEANLEITUNG

3

ASSEMBLY
MONTAJE

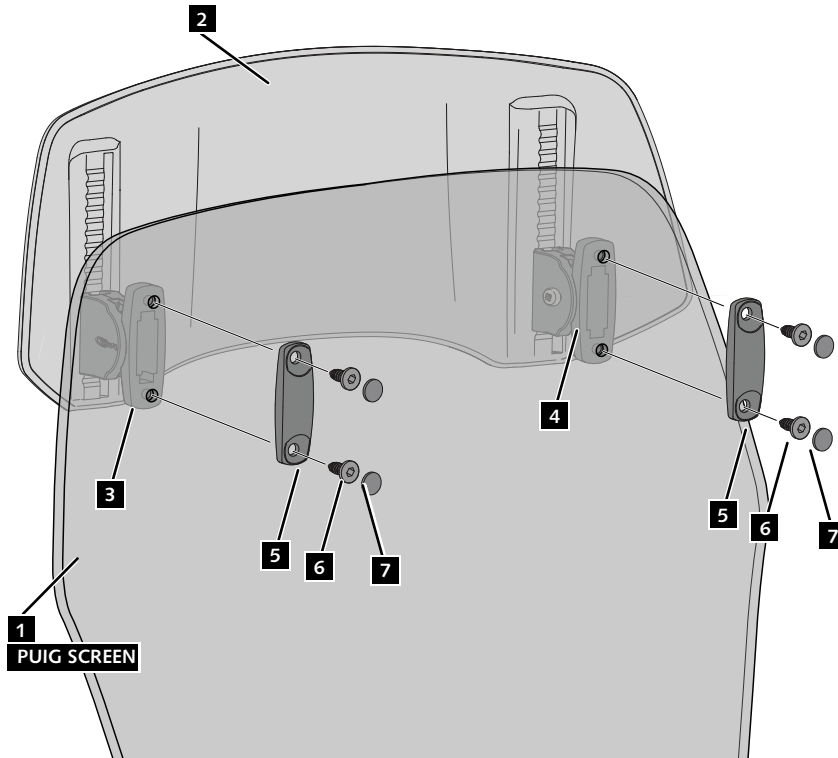

4

DISASSEMBLY
DESMONTAJE

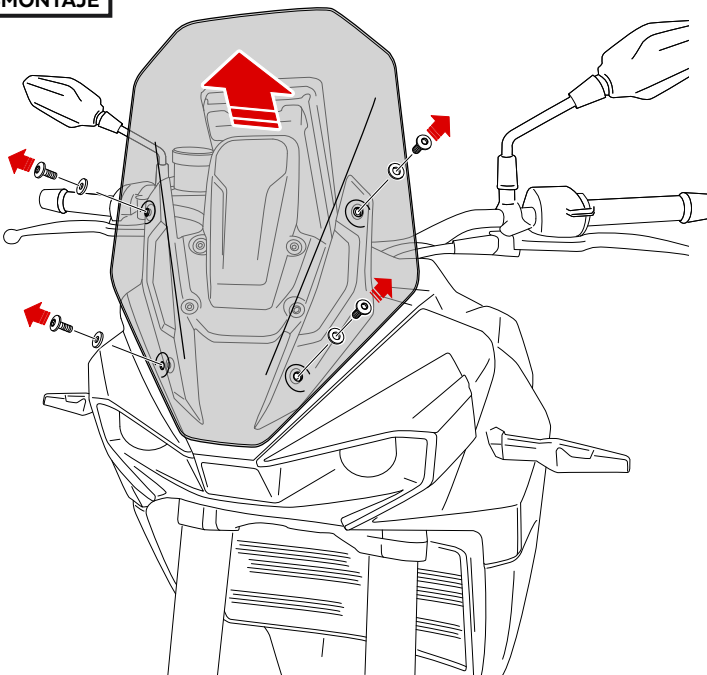

5

ASSEMBLY
MONTAJE

