

HONDA CB1000 HORNET '25-

M O U N T I N G I N S T R U C T I O N S

REF 22382

WINDSHIELD NG TOURING



1 Person









20 min

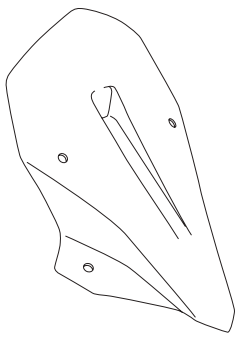
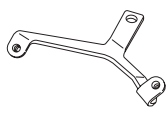
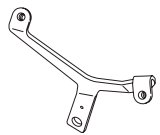

EASY



ALLEN 
Nº 3
Nº 6
Nº 8

ID	PIEZA/PART	DESCRIPCIÓN	DESCRIPTION	QTY	REF
1		Cúpula Touring	Touring screen	1	22382H/W/F/NM3
2		Soporte izquierdo	Left support	1	SOPOR2P2-L22382
3		Soporte derecho (●)	Right support (●)	1	SOPOR2P2-R22382
4		Tornillo Allen M8x40 DIN 912	M8x40 DIN 912 allen screw	2	TORNI-D912--549
5		Casquillo Ø8,5x Ø13x 15	Ø8,5x Ø13x 15 arrowhead	2	CASQUI-M----614
6		Silentblock Ø12xØ6x9	Ø12xØ6x9 silentblock	4	AROPASACABLES-1
7		Casquillo con valona Ø12xØ6,8x7,3	Ø12xØ6,8x7,3 bush with flange	4	CASQUI-1A---750
8		Tornillo Allen M5x12 Ø11 ISO 7380	M5x12 Ø11 ISO 7380 Allen screw	4	TORNI-AI-----520
9		Tapón tornillo M5 ISO 7380	M5 ISO 7380 screw cap	4	TAPON-----85

* Algunos componentes se suministran montados.
Some components are supplied assembled.

HONDA CB1000 HORNET '25-

INSTRUCCIONES DE MONTAJE - MOUNTING INSTRUCTIONS - MONTAGEANLEITUNG

1

**DISASSEMBLY
DESMONTAJE**

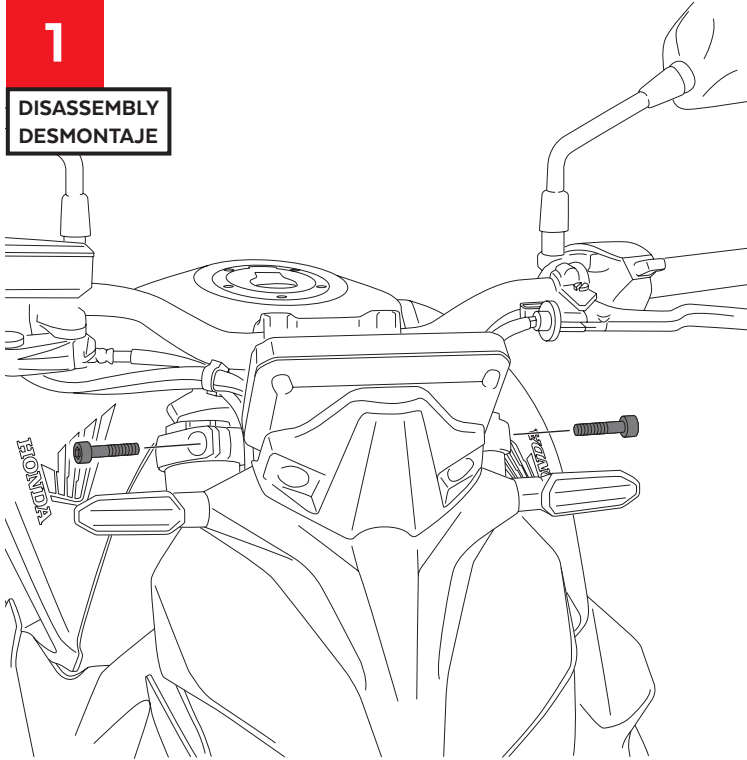

2

**ASSEMBLY
MONTAJE**

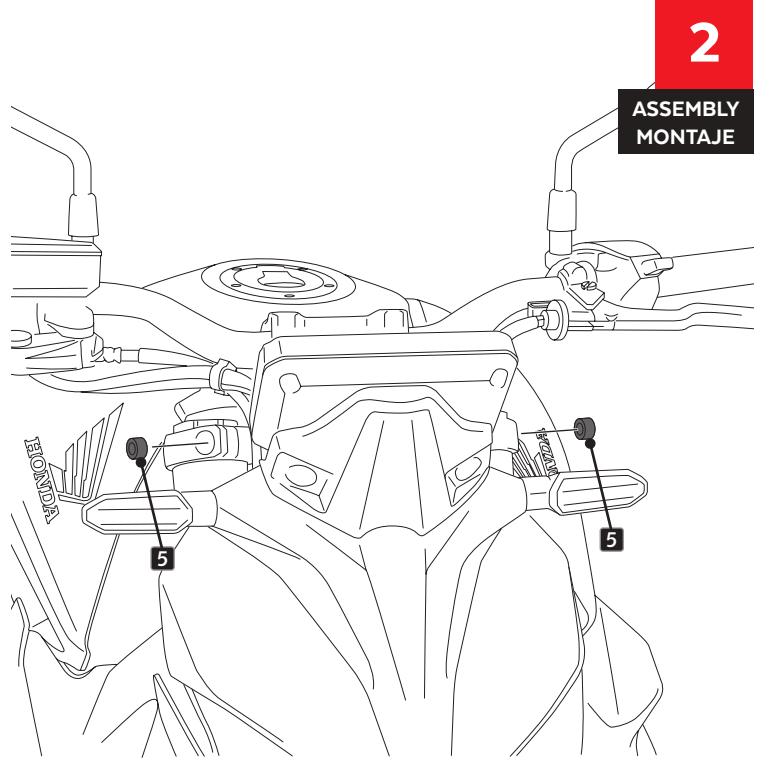

3

**ASSEMBLY
MONTAJE**

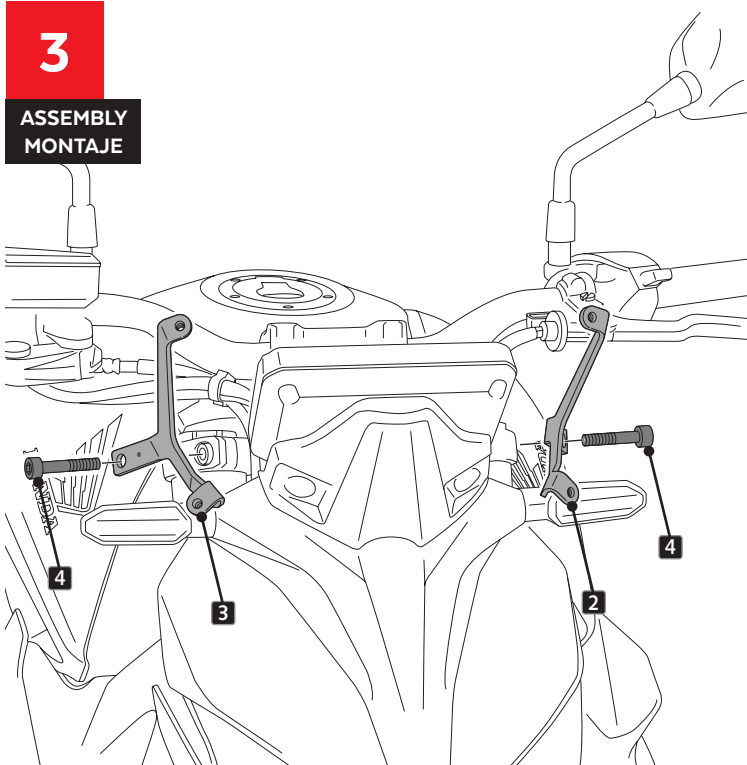



**ADJUST THE POSITION OF ID2 AND ID3 SUPPORTS
AND TIGHTEN ID8 SCREWS**

4

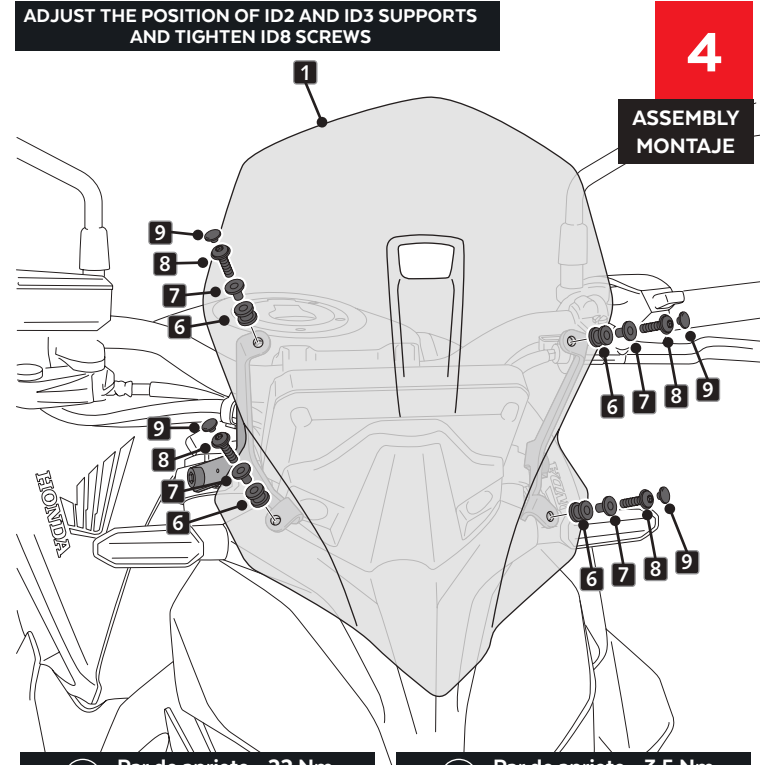
**ASSEMBLY
MONTAJE**



8  Par de apriete - 22 Nm
Tightening torque - 22 Nm

4  Par de apriete - 3,5 Nm
Tightening torque - 3,5Nm