

**CONTRAPESO BALANCE
BAR ENDS BALANCE**

REF 22097N

M O U N T I N G I N S T R U C T I O N S



1 Person



15 min



EASY

14 anillos (2 por color):
Negro, Azul, Rojo, Naranja, Oro, Plata, Verde
14 rings (2 each color):
Black, Blue, Red, Orange, Gold, Silver, Green

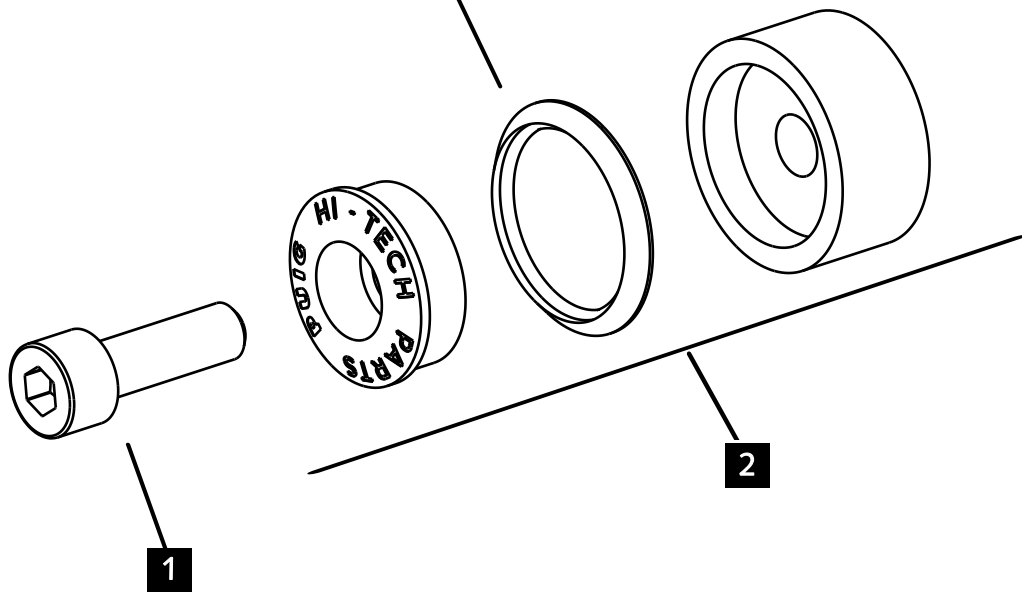

ID.	DESCRIPCIÓN	DESCRIPTION	QTY.
1	Tornillo M8x25 DIN912	M8x25 DIN912 screw	2
2	Contrapeso	Bar end	2

**CONSULTAR EN NUESTRA PAGINA WEB LA DISPONIBILIDAD DEL VIDEO DE MONTAJE DE ESTA REFERENCIA.
CONSULT OUR WEBSITE THE VIDEO MOUNT AVAILABILITY OF THIS REFERENCE.**