

YAMAHA MT 09 '24-

M O U N T I N G I N S T R U C T I O N S

REF 22080

DOWNFORCE NAKED SIDE SPOILERS



ALLEN
Nº 3
Nº 5

ID	PIEZA/PART	DESCRIPCIÓN	DESCRIPTION	QTY	REF
1		Alerón derecho	Right spoiler	1	22080J/CM3
2		Alerón izquierdo	Left spoiler	1	22080J/CM3
3		Soporte inferior derecho	Lower right support	1	SOPO10P31R22080
4		Soporte superior derecho	Upper right suport	1	SOPO10P3SR22080
5		Soporte tapa intermitente derecho	Right turn lights cover support	1	SOPO10P3TR22080
6		Soporte tapa intermitente posterior der.	Rear right turn lights cover support	1	SOPO10P3PR22080
7		Soporte intermitente derecho	Right turn lights support	1	SOPO10P3DR22080
8		Soporte inferior izquierdo	Lower left support	1	SOPO10P3IL22080
9		Soporte superior izquierdo	Upper left suport	1	SOPO10P3SL22080
10		Soporte tapa intermitente izquierdo	Left turn lights cover support	1	SOPO10P3TL22080
11		Soporte tapa intermitente posterior izq.	Rear left turn lights cover support	1	SOPO10P3PL22080
12		Soporte intermitente izquierdo	Left turn lights support	1	SOPO10P3DL22080
13		Tornillo Allen M5x20 Ø11 ISO 7380	M5x20 Ø11 ISO 7380 Allen screw	4	TORNI-I7380-730
14		Casquillo Ø8,5 x Ø13 x 6mm	Ø8,5 x Ø13 x 6mm arrowhead	2	CASQUI-----776
15		Casquillo Ø8,5 x Ø13 x 3,5mm	Ø8,5 x Ø13 x 3,5mm arrowhead	2	CASQUI-----775
16		Tope de goma Ø10,5 x Ø7,9 mm	Ø10,5 x Ø7,9 mm Bumper foot	10	TAPON-----95
17		Tornillo Allen M5x12 Ø11 ISO 7380	M5x12 Ø11 ISO 7380 Allen screw	2	TORNI-AI----520
18		Tapón tornillo M5 ISO 7380	M5 ISO 7380 screw cap	2	TAPON-----85
19		Tornilo allen M5 DIN7991	M5 DIN 7991 Allen screw	6	TORNI-D7991-611
20		Arandela de goma Ø4,5 x Ø11 x 2mm	Ø4,5 x Ø11 x 2mm rubber washer	6	ARAND-EPDM--722
21		Tuerca de clip M5	M5 clip nut	2	TUERCA-TRT-M5--
22		Tapón tornillo M5 DIN7991	M5 DIN7991 screw cap	6	TAPON-----92

YAMAHA MT 09 '24-

INSTRUCCIONES DE MONTAJE - MOUNTING INSTRUCTIONS - MONTAGEANLEITUNG

1

DISASSEMBLY
DESMONTAJE

Se muestra el montaje del lado derecho a modo de ejemplo, realizar los mismos pasos para el montaje del lado izquierdo.
The right side assembly is shown as an example, so the same steps can be performed for the left side assembly.

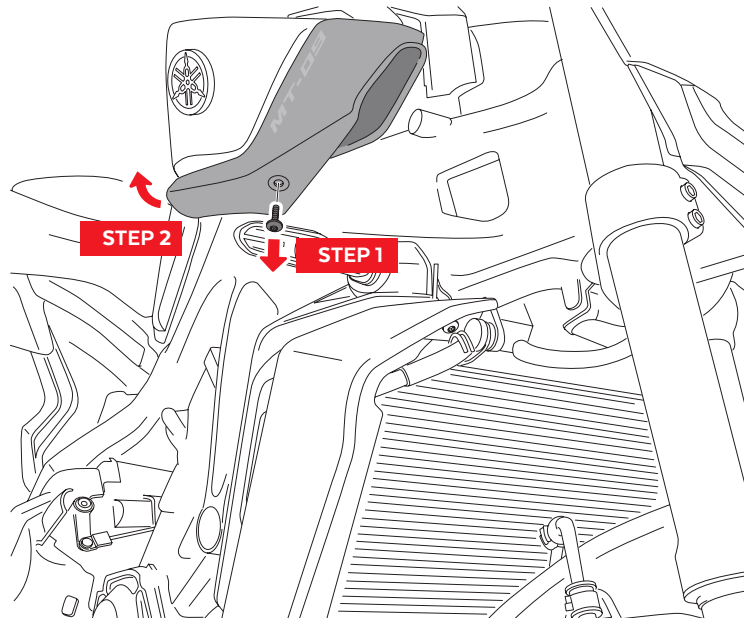

2

DISASSEMBLY
DESMONTAJE

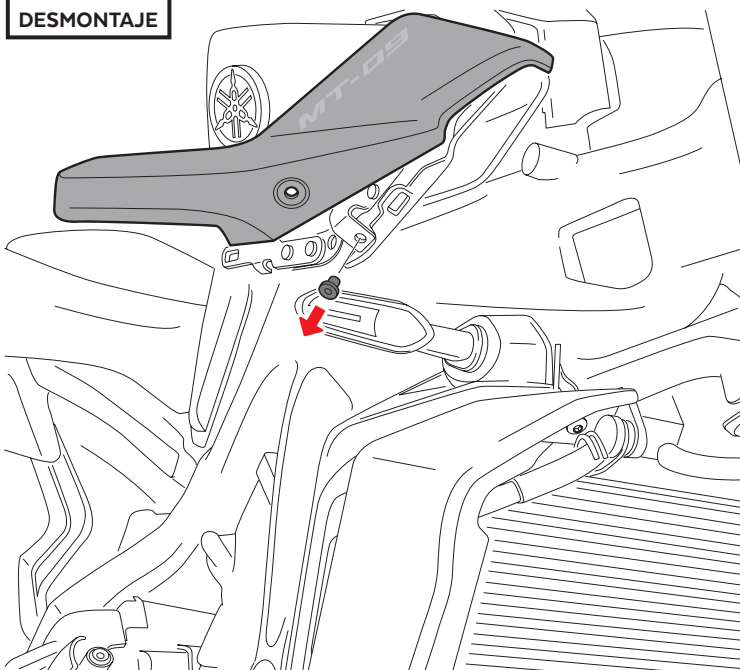

3

ASSEMBLY
MONTAJE

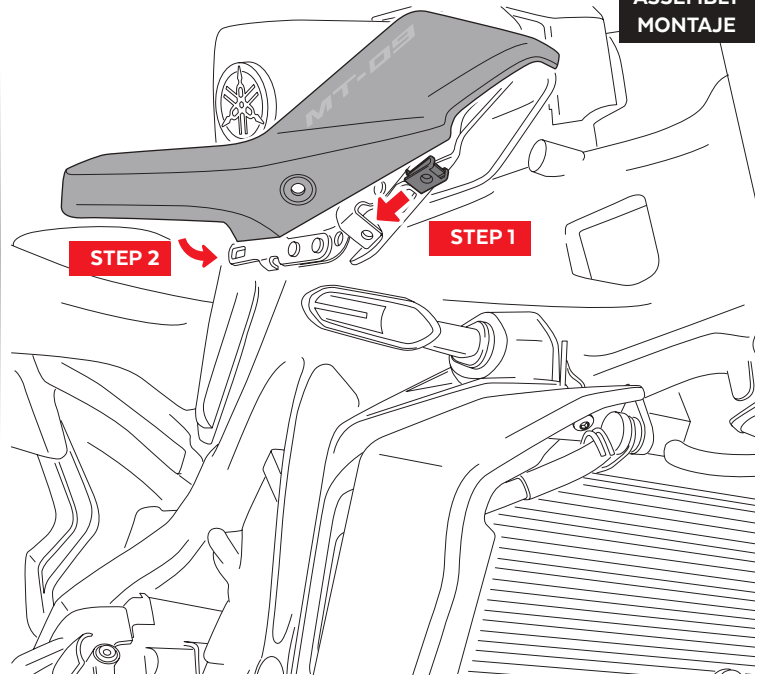

YAMAHA MT 09 '24-

INSTRUCCIONES DE MONTAJE - MOUNTING INSTRUCTIONS - MONTAGEANLEITUNG

4

**ASSEMBLY
MONTAJE**

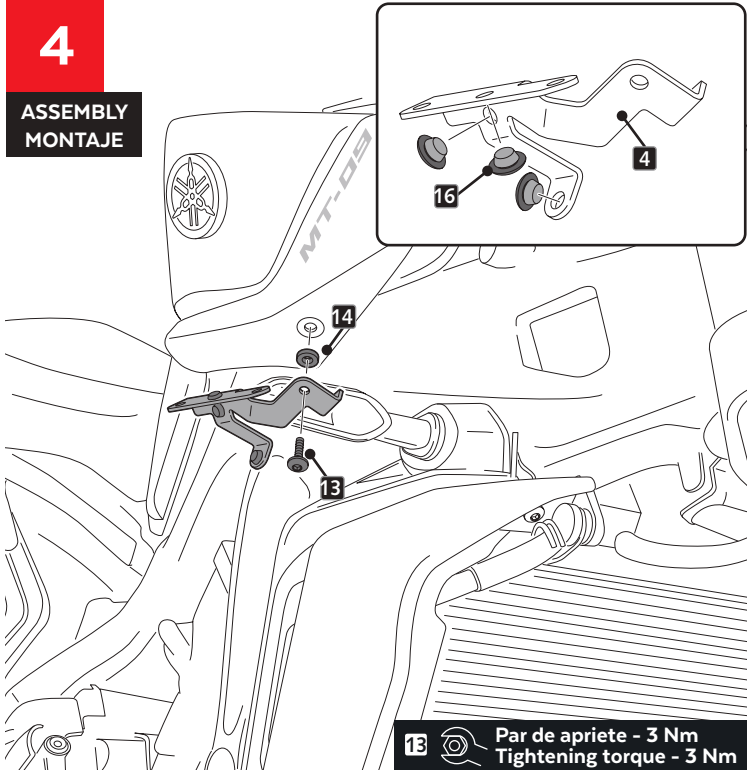
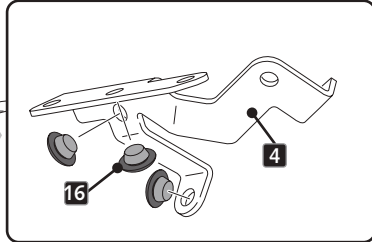

13 Par de apriete - 3 Nm
Tightening torque - 3 Nm

5

**DISASSEMBLY
DESMONTAJE**

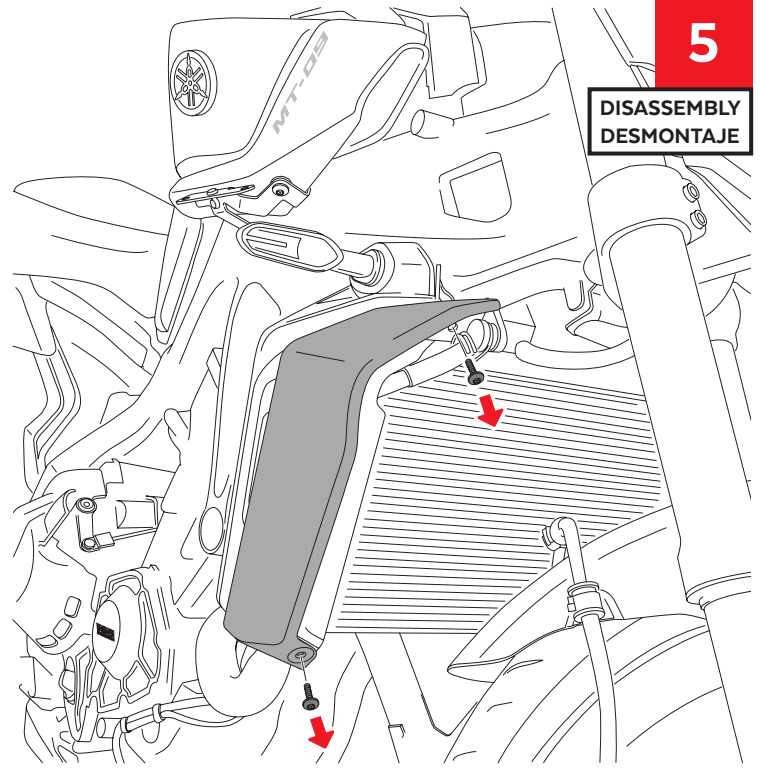

6

**DISASSEMBLY
DESMONTAJE**

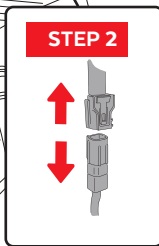
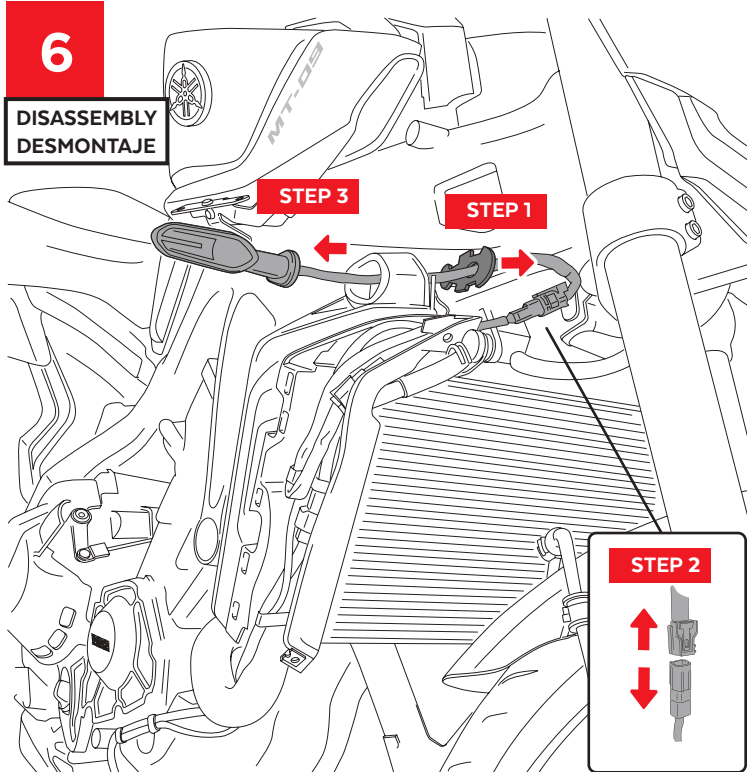

7

**ASSEMBLY
MONTAJE**

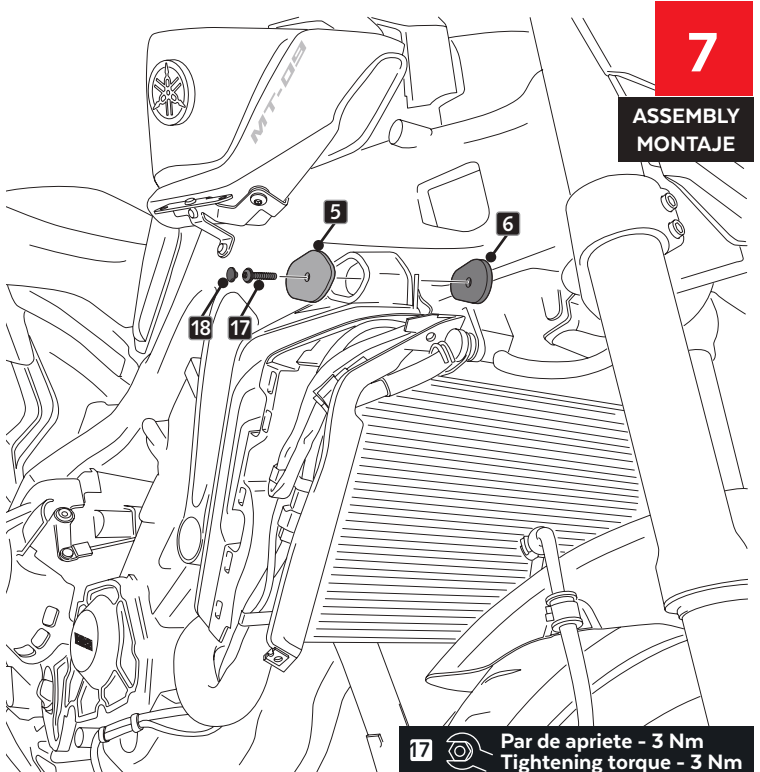

17 Par de apriete - 3 Nm
Tightening torque - 3 Nm

YAMAHA MT 09 '24-

INSTRUCCIONES DE MONTAJE - MOUNTING INSTRUCTIONS - MONTAGEANLEITUNG

8

**DISASSEMBLY
DESMONTAJE**

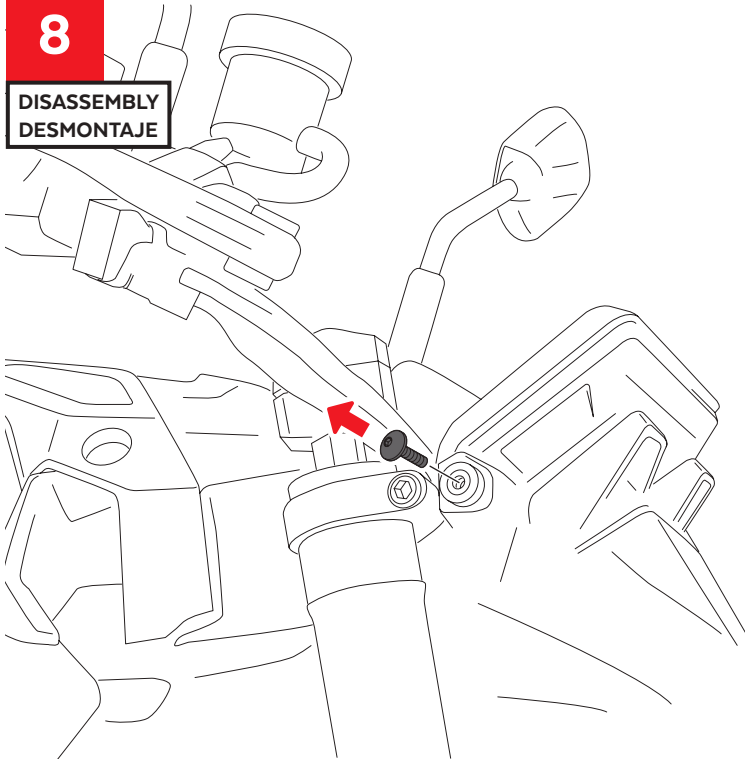

9

**ASSEMBLY
MONTAJE**

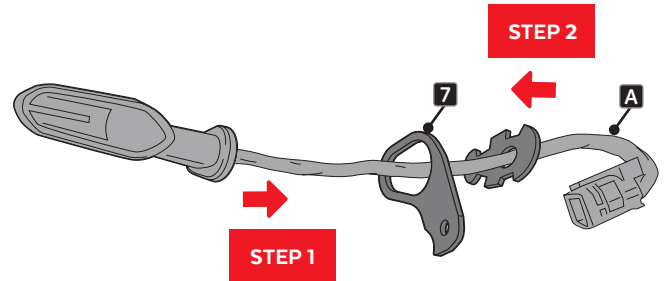

A PIEZA ORIGINAL
ORIGINAL PART

10

**ASSEMBLY
MONTAJE**

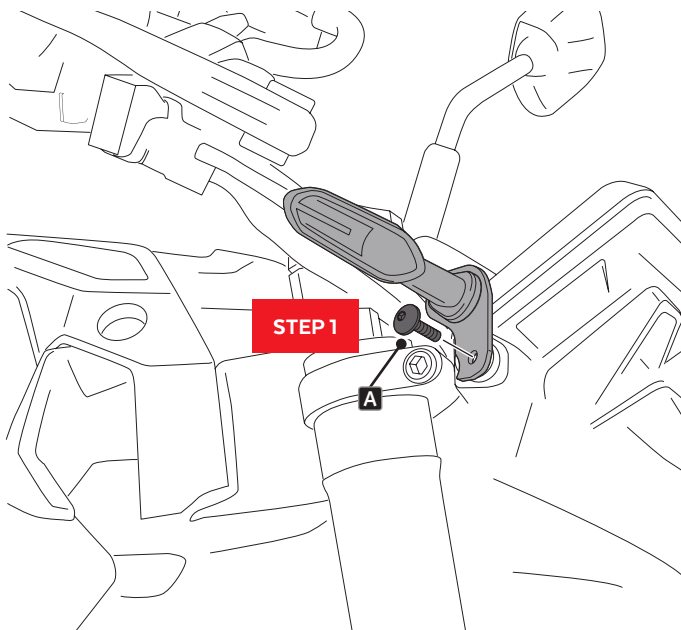

A PIEZA ORIGINAL
ORIGINAL PART

STEP 2

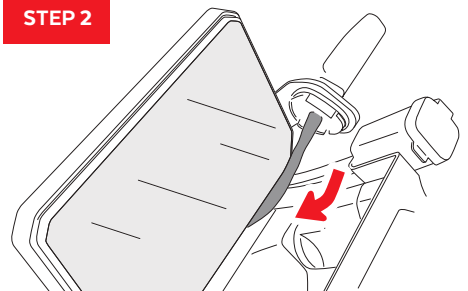

**PASAR EL CABLE ENTRE EL RELOJ
Y LA PLATINA SUPERIOR.**

**PASS THE WIRE BETWEEN THE
CLOCK AND THE UPPER PLATE.**

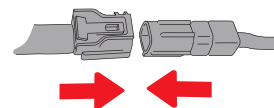

STEP 3

YAMAHA MT 09 '24-

INSTRUCCIONES DE MONTAJE - MOUNTING INSTRUCTIONS - MONTAGEANLEITUNG

11

ASSEMBLY
MONTAJE

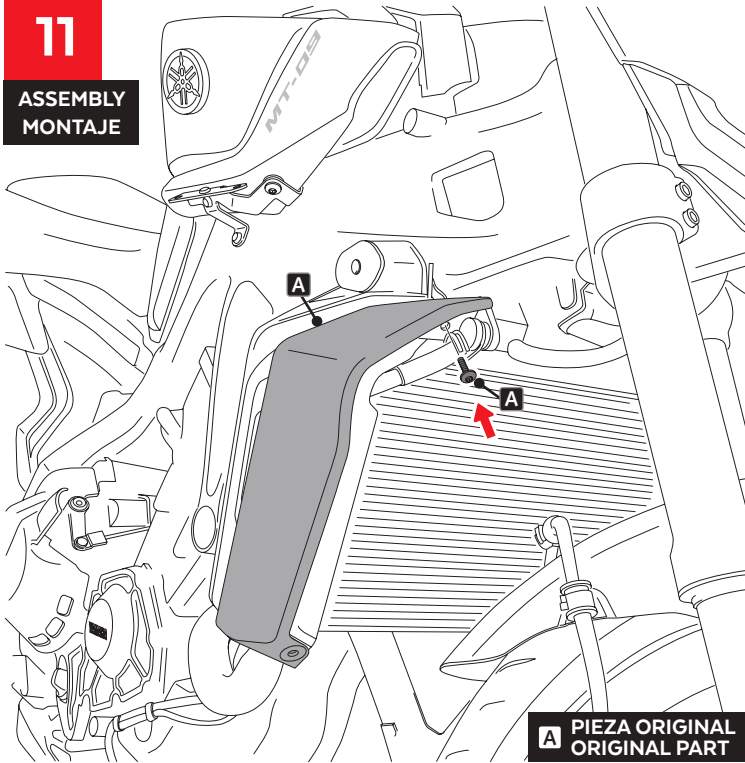

A PIEZA ORIGINAL
ORIGINAL PART

12

ASSEMBLY
MONTAJE

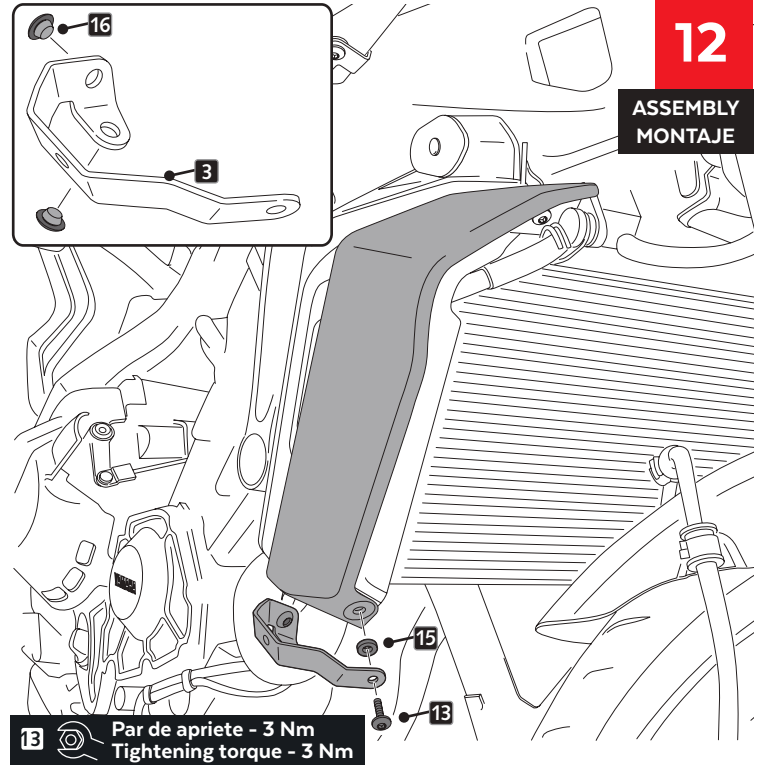

13 Par de apriete - 3 Nm
Tightening torque - 3 Nm

13

ASSEMBLY
MONTAJE

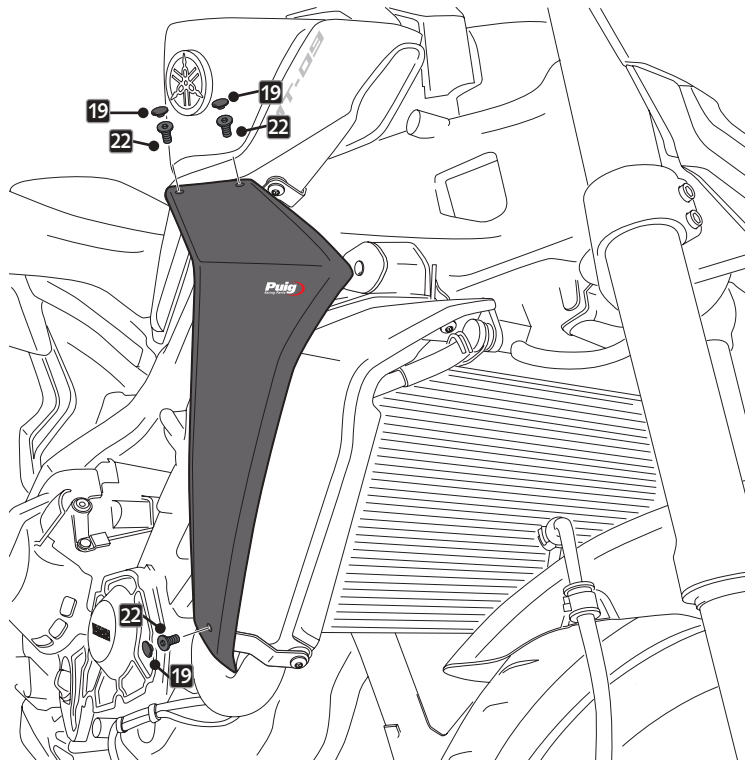
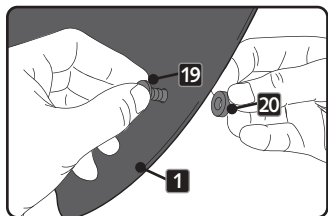

19 Par de apriete - 3 Nm
Tightening torque - 3 Nm