

KAWASAKI ZX-6R NINJA '24-

M O U N T I N G I N S T R U C T I O N S

VIDEO

REF 21858

DOWNFORCE RACE SIDE SPOILERS



PHILLIPS



FIX
Nº 8



ALLEN
Nº 3
Nº 4



ID	PIEZA/PART	DESCRIPCIÓN	DESCRIPTION	QTY	REF
1		Alerón izquierdo	Left spoiler	1	21858N/V/J/CM3
2		Alerón derecho	Right spoiler	1	21858N/V/J/CM3
3		Soporte izquierdo (L)	Left support (L)	1	SOPOR2P5-L21858
4		Soporte derecho (R)	Right support (R)	1	SOPOR2P5-R21858
5		Pieza soporte alerón (tamaño grande)	Spoiler support piece	2	SOPOR-S---20431
6		Tuerca grafilada M5	M5 nut	4	TUERC-D6923-255
7		Arandela de goma Ø4,5 x Ø11 x 2mm	Ø4,5 x Ø11 x 2mm ruber washer	4	ARAND-EPDM--722
8		Tornillo M5x12 DIN7991	M5x12 DIN7991 Screw	4	TORNI-D7991-611
9		Tapón tornillo M5 DIN7991	M5 DIN7991 Screw cap	4	TAPON-----92
10		PIN Ø6,35mm / Ø4mm	Ø6,35mm / Ø4mm PIN	2	PIN-----21858
11		Arandela de nylon Ø6,2 x Ø12 x 3mm	Ø6,2 x Ø12 x 3mm nylon washer	2	ARAND-----749
12		Tornillo Allen M5x20 Ø11 ISO 7380	M5x20 Ø11 ISO 7380 Allen screw	2	TORNI-I7380-730
13		Lápiz AP111 Adhesion promoter	AP111 adhesion promoter Pen	1	KITNETEJA3M----
14		Espuma adhesiva protectora (105mm)	Protective adhesive foam (105mm)	1	ESPUM-NC+ADHM--

KAWASAKI ZX-6R NINJA '24-

INSTRUCCIONES DE MONTAJE - MOUNTING INSTRUCTIONS - MONTAGEANLEITUNG

1

DISASSEMBLY
DESMONTAJE

Se muestra el montaje del lado derecho a modo de ejemplo, realizar los mismos pasos para el montaje del lado izquierdo.
The right side assembly is shown as an example, so the same steps can be performed for the left side assembly.

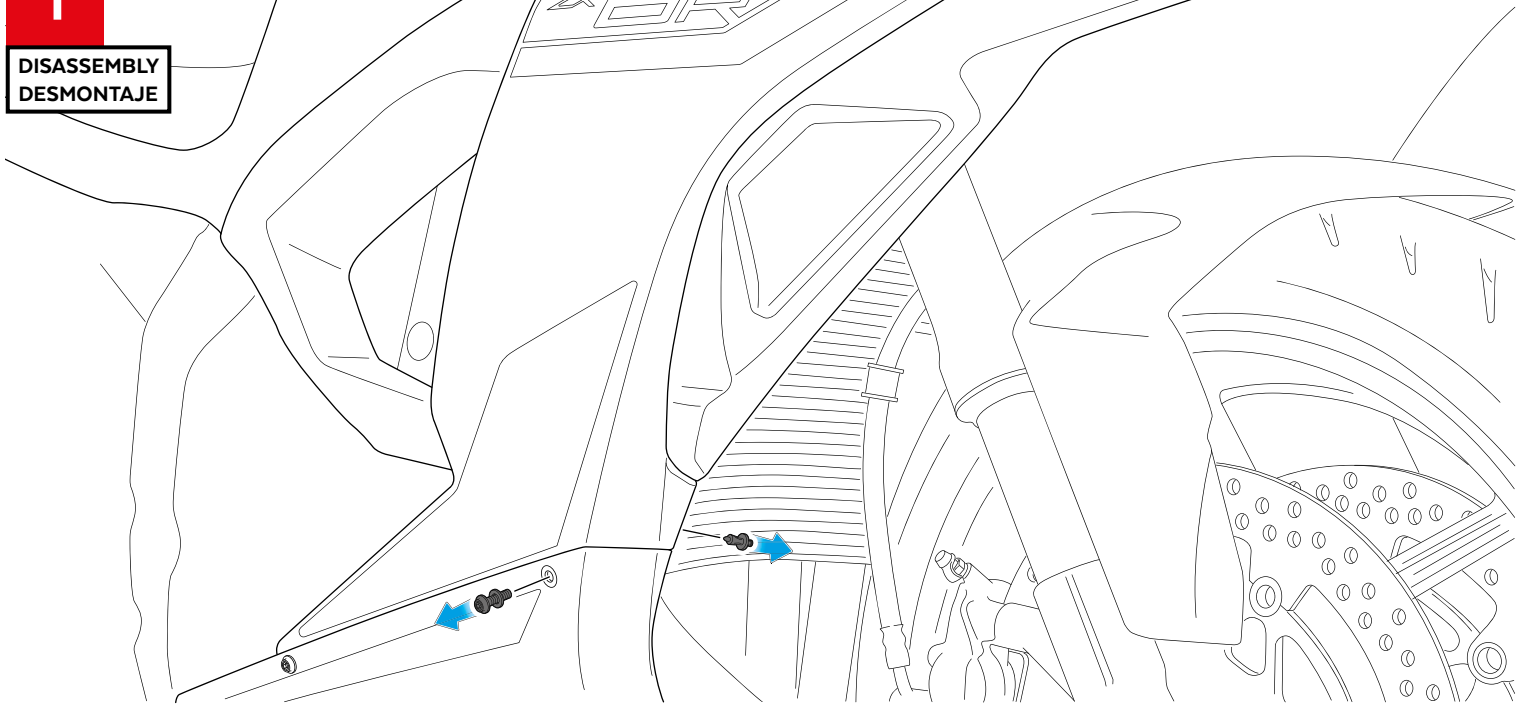

2

ASSEMBLY
MONTAJE

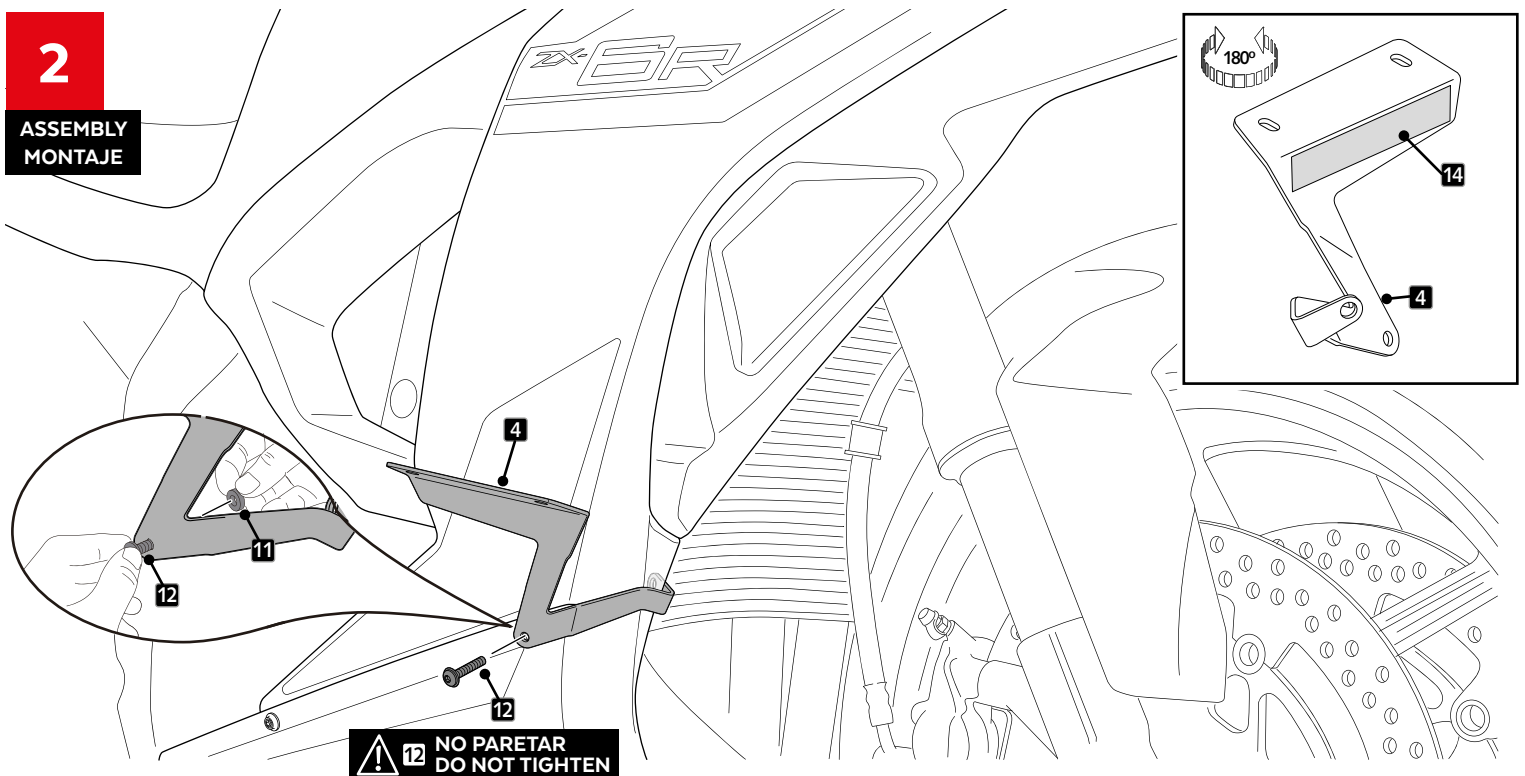

KAWASAKI ZX-6R NINJA '24-

INSTRUCCIONES DE MONTAJE - MOUNTING INSTRUCTIONS - MONTAGEANLEITUNG

3

ASSEMBLY
MONTAJE

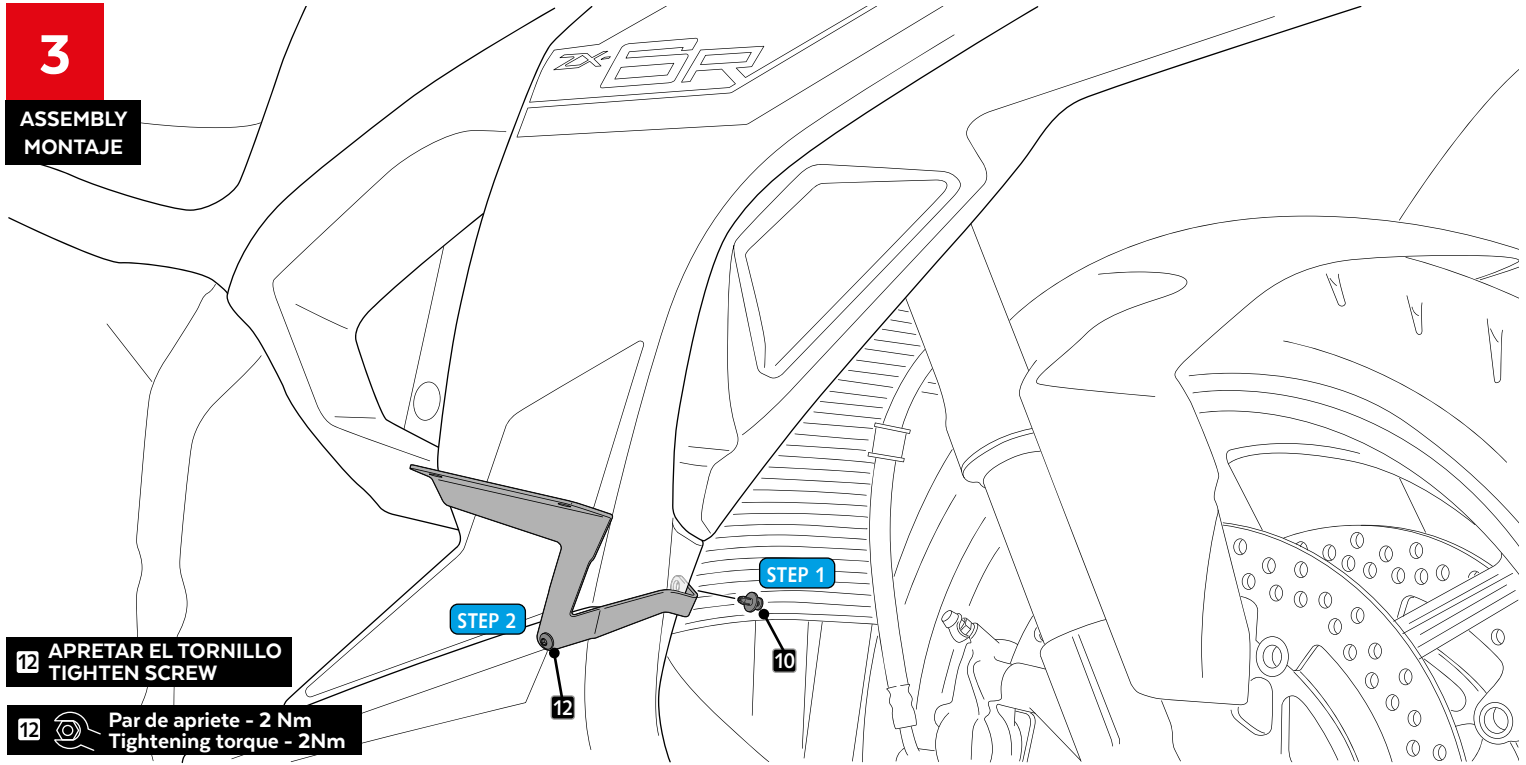

4

ASSEMBLY
MONTAJE

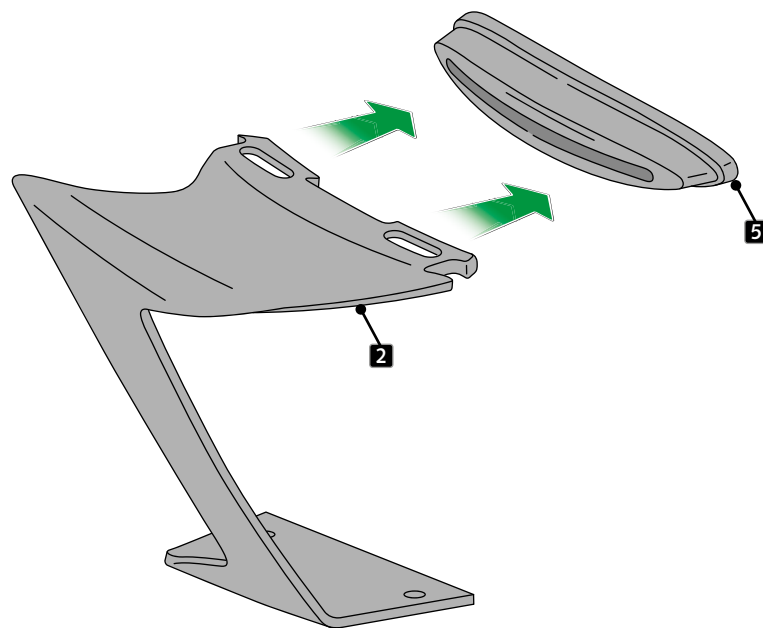

KAWASAKI ZX-6R NINJA '24-

INSTRUCCIONES DE MONTAJE - MOUNTING INSTRUCTIONS - MONTAGEANLEITUNG

5

ASSEMBLY
MONTAJE

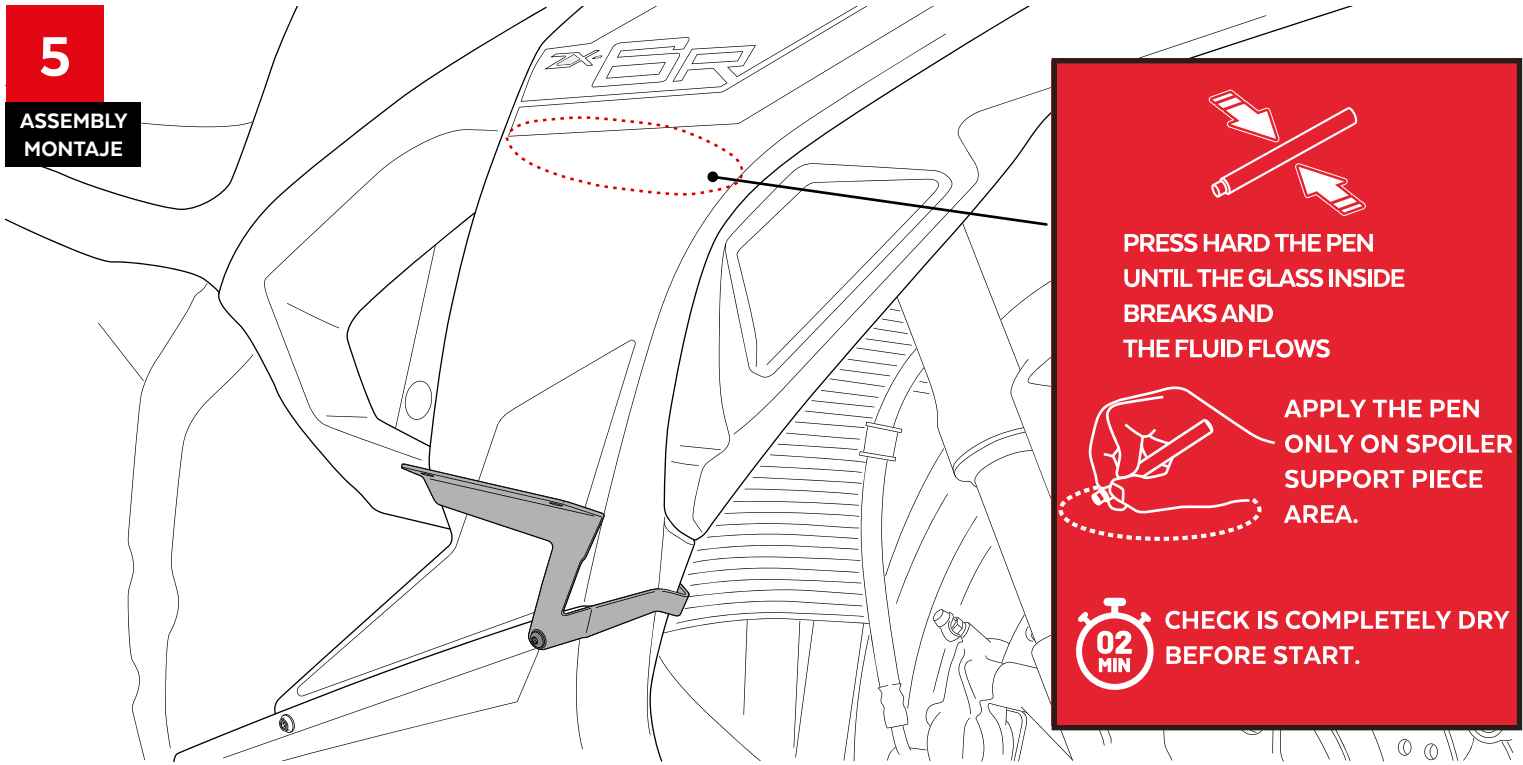

6

ASSEMBLY
MONTAJE

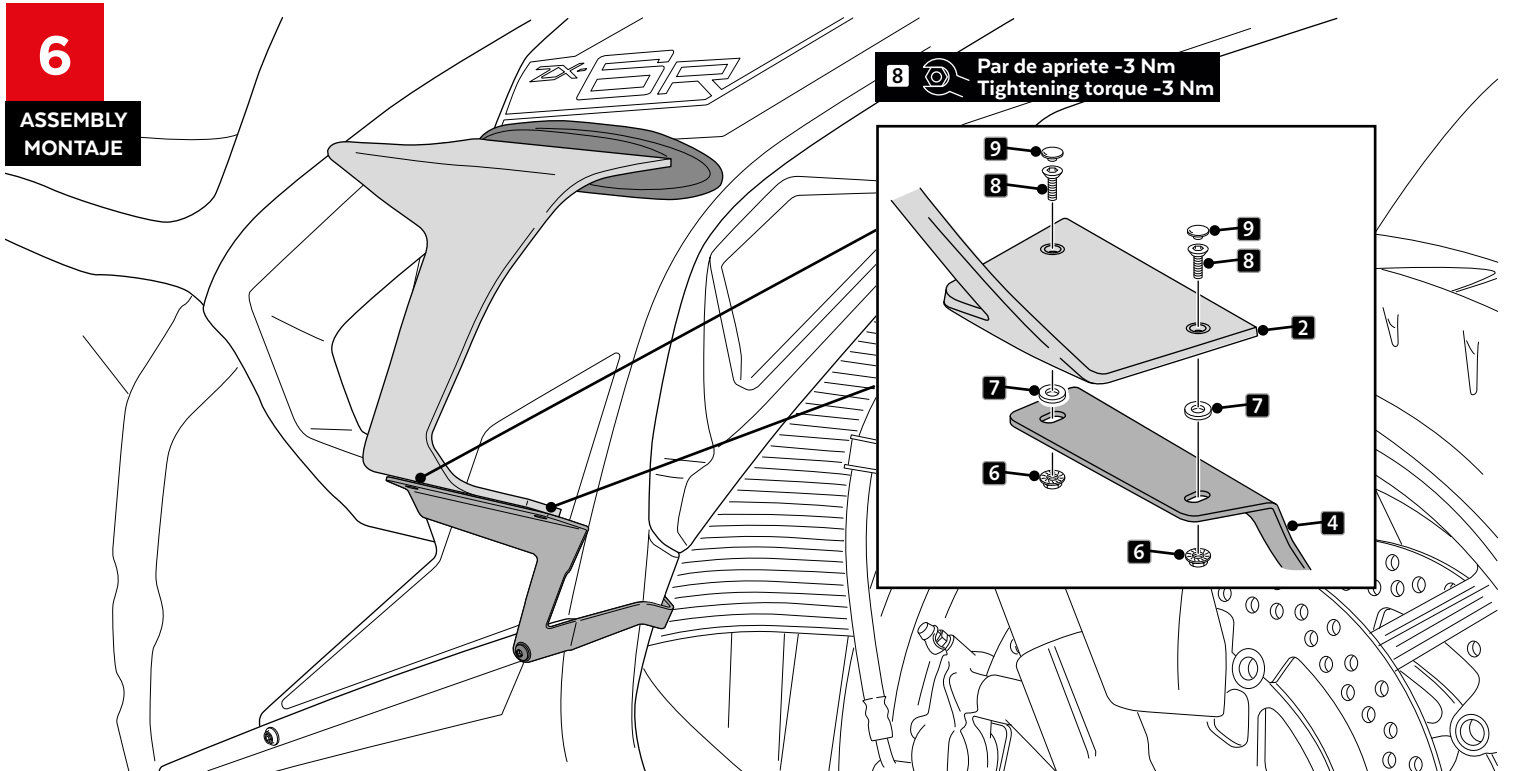

KAWASAKI ZX-6R NINJA '24-

INSTRUCCIONES DE MONTAJE - MOUNTING INSTRUCTIONS - MONTAGEANLEITUNG

7

ASSEMBLY
MONTAJE

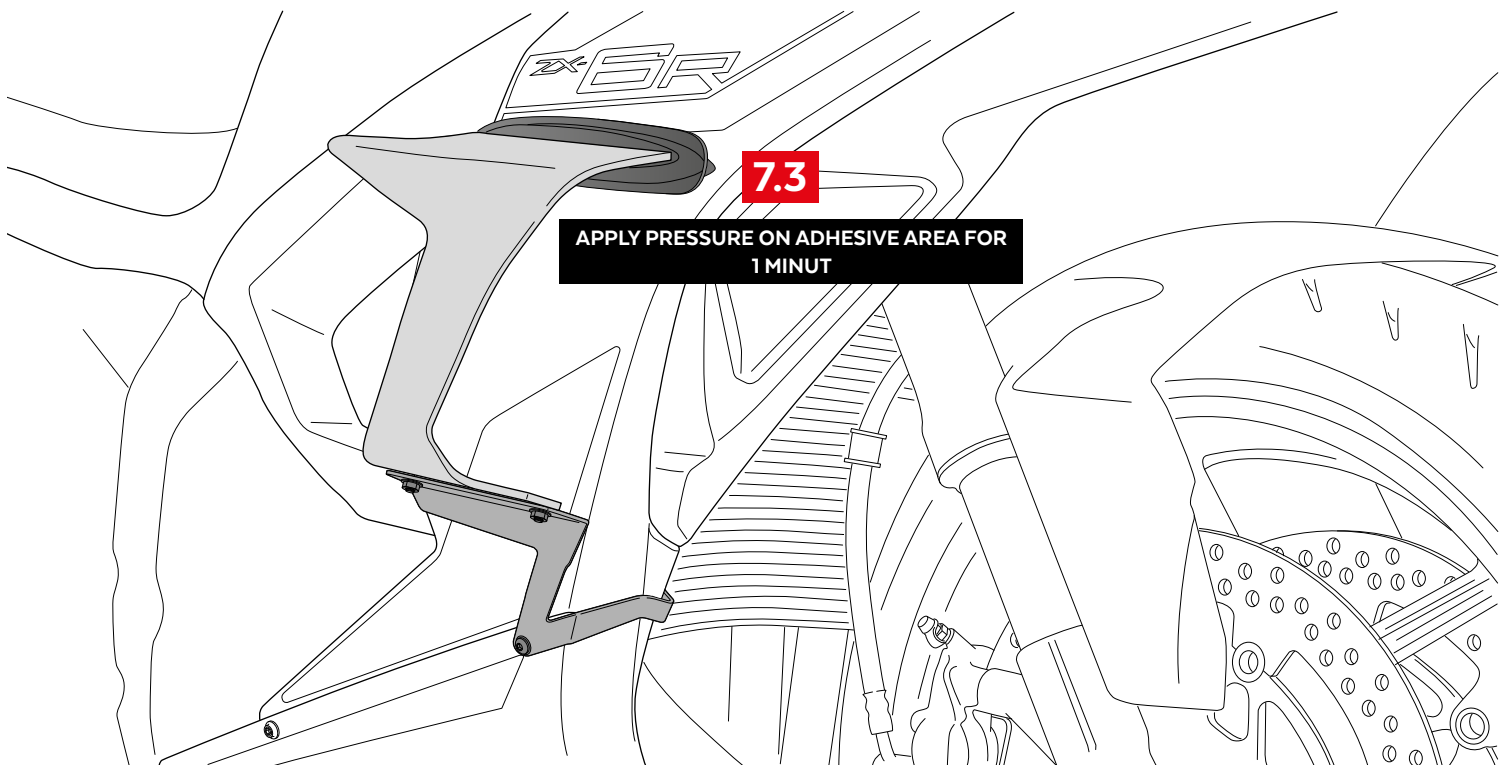
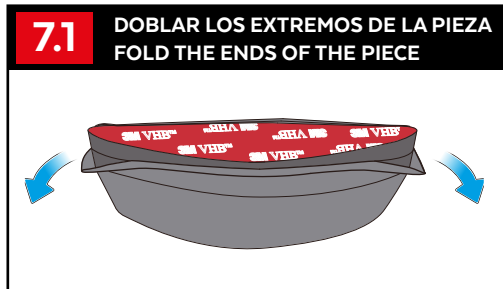

KAWASAKI ZX-6R NINJA '24-

INSTRUCCIONES DE MONTAJE - MOUNTING INSTRUCTIONS - MONTAGEANLEITUNG

8

ASSEMBLY
MONTAJE

WAIT 24 HOURS



CHECK THE CORRECT ADHESION
OF THE 3M DOUBLE SIDE
SELF-ADHESIVE TAPE
TO THE FAIRING. ENSURE THAT
THE ENTIRE SURFACE
IS WELL ADHERED

9

ASSEMBLY
MONTAJE

DESDOBLAR LOS EXTREMOS DE LA PIEZA
UNFOLD THE ENDS OF THE PIECE

