

YAMAHA XSR700 '22-

M O U N T I N G I N S T R U C T I O N S

REF 21430

WINDSHIELD NG SPORT



1 Person



30 min











EASY

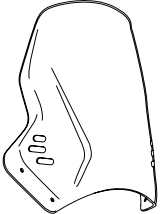

ALLEN

Nº 3
Nº 4
Nº 5



ID.	PIEZA/PART	DESCRIPCIÓN	DESCRIPTION	QTY.	REF.:
1		Cúpula Sport	Sport screen	1	10935H/W/F/NM3
2		Soporte Izquierdo (L)	Left support (L)	1	SOPOR2P4-L21430
3		Soporte derecho (R)	Right support (R)	1	SOPOR2P4-R21430
4		Tornillo Allen M6x30 Ø11 ISO 7380	M6x30 Ø11 ISO 7380 allen screw	4	TORNI-I7380-626
5		Casquillo Ø8,5 xØ13 x6 mm	Ø8,5 xØ13 x6 mm arrowhead	2	CASQUI-----776
6		Silentblock Ø12xØ6x9	Ø12xØ6x9 silentblock	4	AROPASACABLES-1
7		Casquillo con valona Ø12xØ6,8x7,3	Ø12xØ6,8x7,3 bush with flange	4	CASQUI-1A---750
8		Tornillo allen M5x12 Ø11 ISO 7380	M5x12 Ø11 ISO 7380 allen screw	4	TORNI-AI----520
9		Tapón tornillo M5 ISO 7380	M5 ISO 7380 screw cap	4	TAPON-----85

YAMAHA XSR700 '22-

INSTRUCCIONES DE MONTAJE - MOUNTING INSTRUCTIONS - MONTAGEANLEITUNG

1

DISASSEMBLY
DESMONTAJE

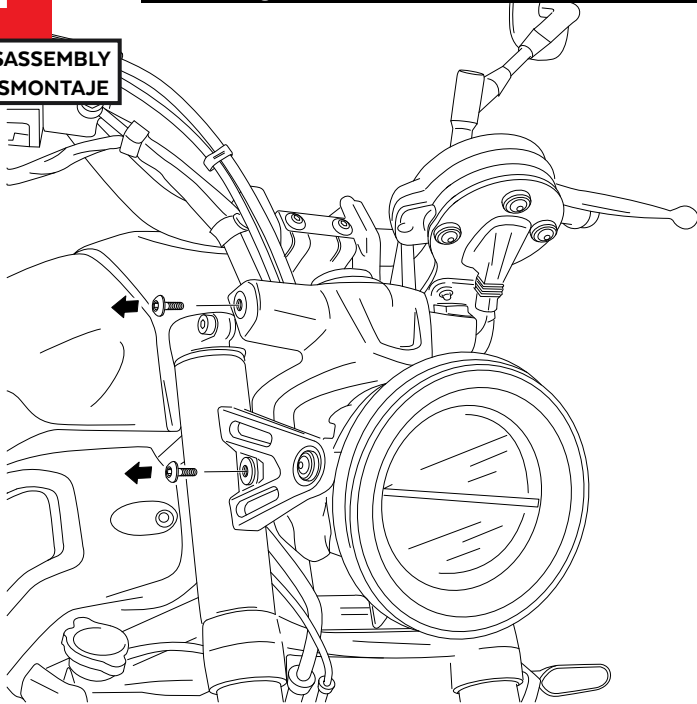

Se muestra el montaje del lado derecho a modo de ejemplo, realizar los mismos pasos para el montaje del lado izquierdo.
The right side assembly is shown as an example, so the same steps can be performed for the left side assembly.

2

ASSEMBLY
MONTAJE

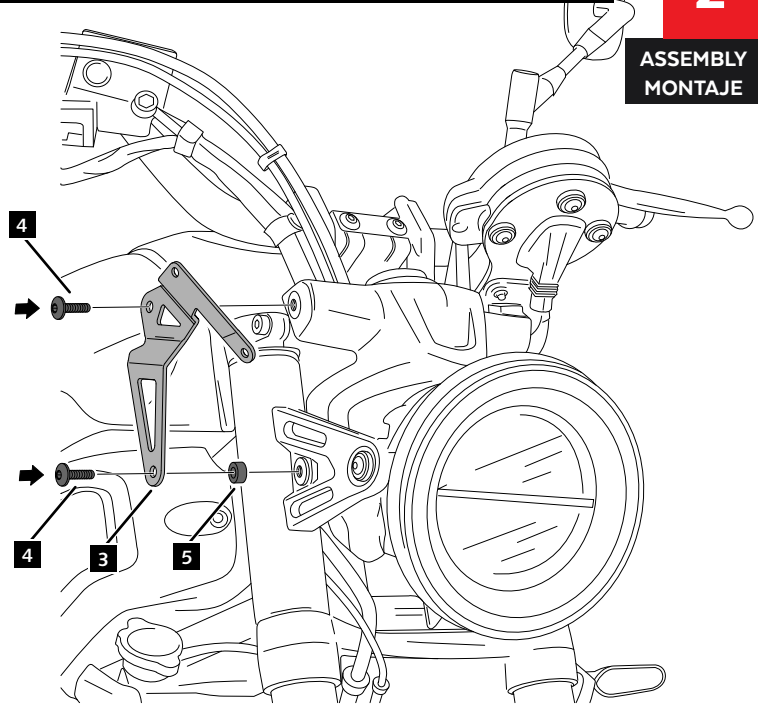

3

ASSEMBLY
MONTAJE

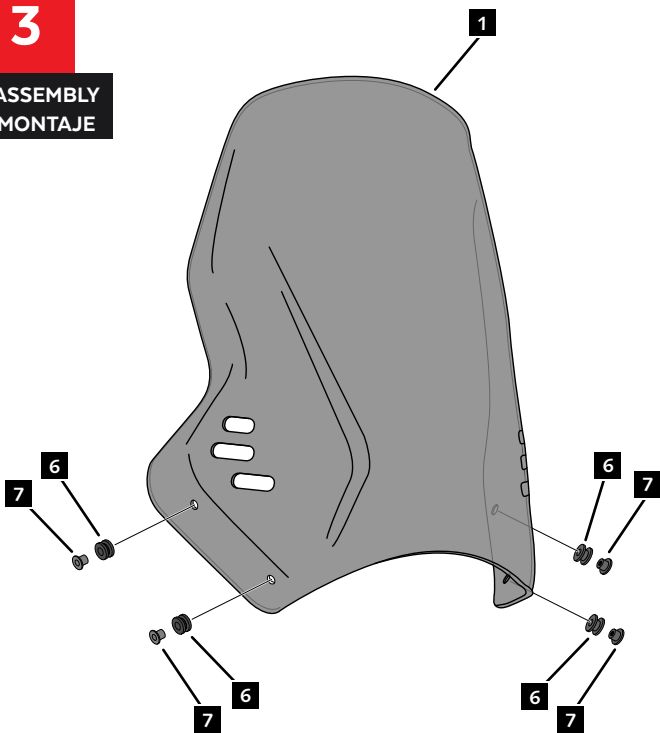

4

ASSEMBLY
MONTAJE

