

# TRIUMPH TIGER SPORT 660 '22

## M O U N T I N G I N S T R U C T I O N S

REF 21317

TOURING SCREEN



1 Person



25 min



EASY







N° 12

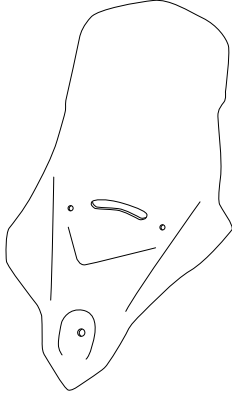
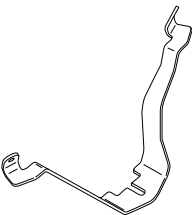

ALLEN

N° 3  
N° 5

ID	PIEZA/PART	DESCRIPCIÓN	DESCRIPTION	QTY	REF
1		Cúpula touring	Touring screen	1	21317W/H/FM3
2		Soporte fijo	Fixed support	1	SOP1P2----21317
3		Arandela de nylon Ø8,2x Ø13x 1mm	Ø8,2x Ø13x 1mm nylon washer	2	ARNV00000000265
4		Tornillo Allen M5x25 Ø11 ISO 7380	M5x25 Ø11 ISO 7380 Allen screw	2	TORNI-I7380-766
5		Casquillo Ø8,5 xØ13 x3,5	Ø8,5 xØ13 x3,5 arrowhead	2	CASQUI-----775

INSTRUCCIONES DE MONTAJE - MOUNTING INSTRUCTIONS - MONTAGEANLEITUNG

1

DISASSEMBLY  
DESMONTAJE

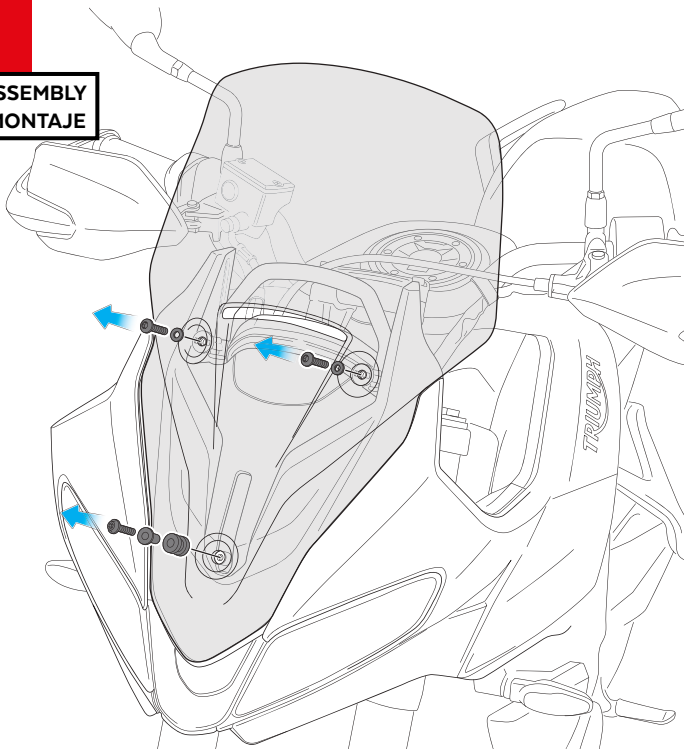

2

DISASSEMBLY  
DESMONTAJE

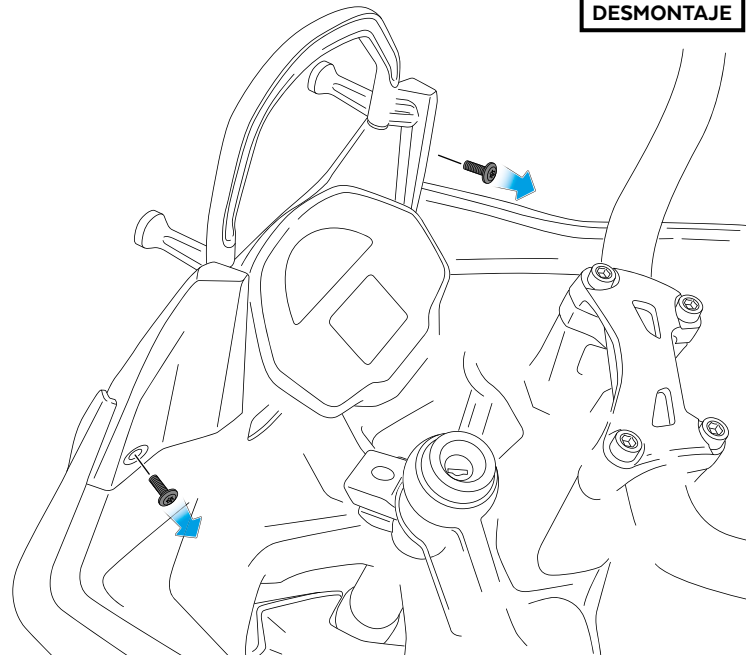

3

DISASSEMBLY  
DESMONTAJE

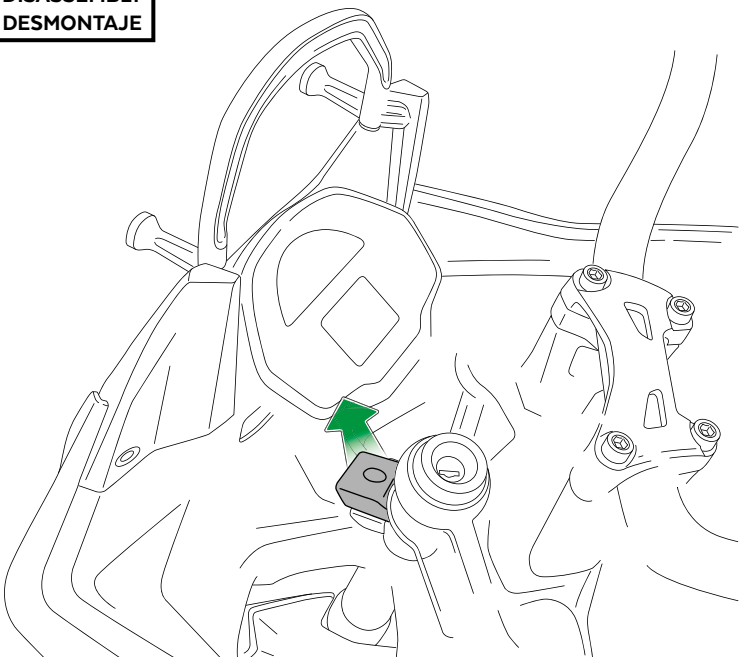

4

DISASSEMBLY  
DESMONTAJE

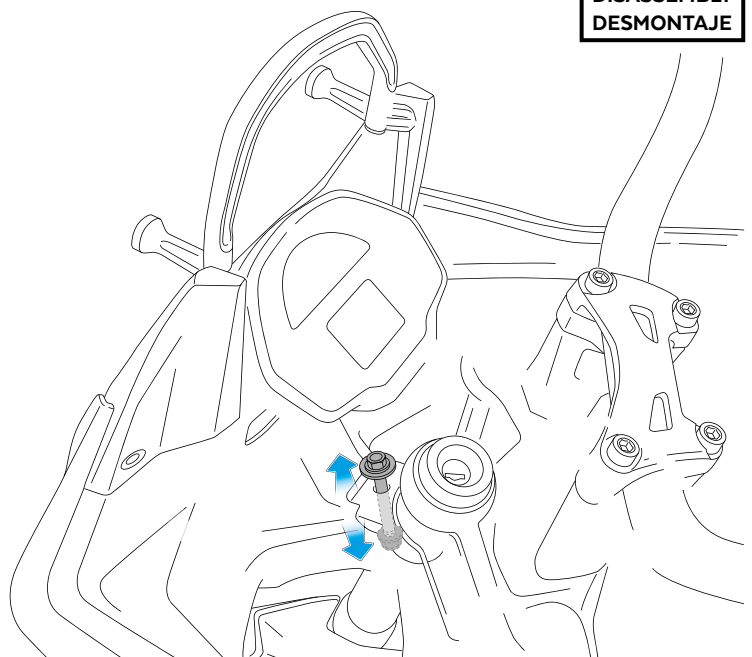

INSTRUCCIONES DE MONTAJE - MOUNTING INSTRUCTIONS - MONTAGEANLEITUNG

**5**

ASSEMBLY  
MONTAJE

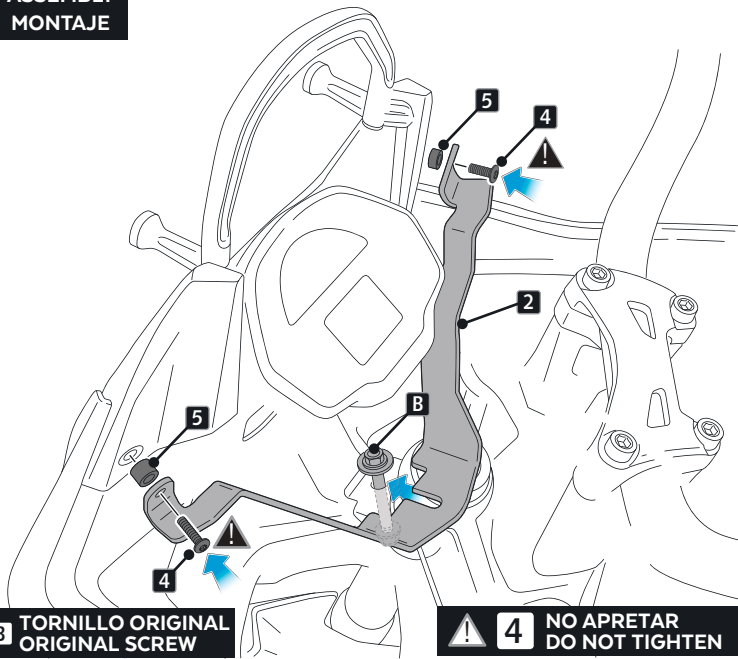

**B** TORNILLO ORIGINAL  
ORIGINAL SCREW

**!** **4** NO APRETAR  
DO NOT TIGHTEN

**6**

ASSEMBLY  
MONTAJE

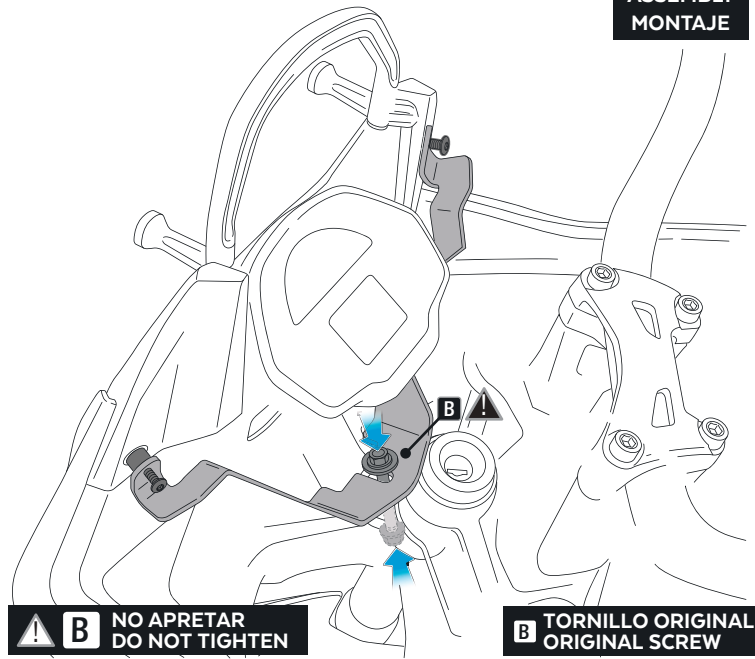

**!** **B** NO APRETAR  
DO NOT TIGHTEN

**B** TORNILLO ORIGINAL  
ORIGINAL SCREW

**7**

ASSEMBLY  
MONTAJE

**!**  
**STEP 1.**  
APRETAR TORNILLOS ID4 / TIGHTEN ID4 SCREWS  
**STEP 2.**  
ASEGURAR LA CORRECTA POSICIÓN DEL SOPORTE  
Y APRETAR TORNILLO ORIGINAL/  
ENSURE THE CORRECT POSITION OF THE SUPPORT  
AND TIGHTEN THE ORIGINAL SCREW.

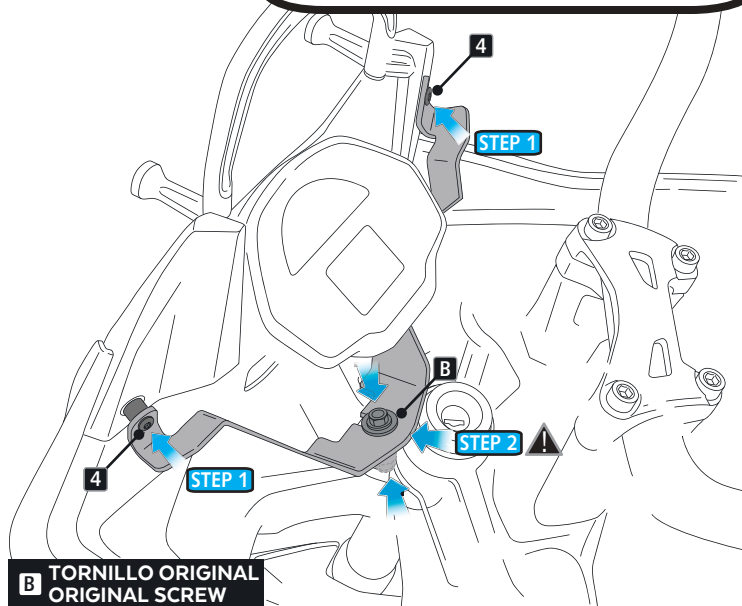

**B** TORNILLO ORIGINAL  
ORIGINAL SCREW

**8**

ASSEMBLY  
MONTAJE

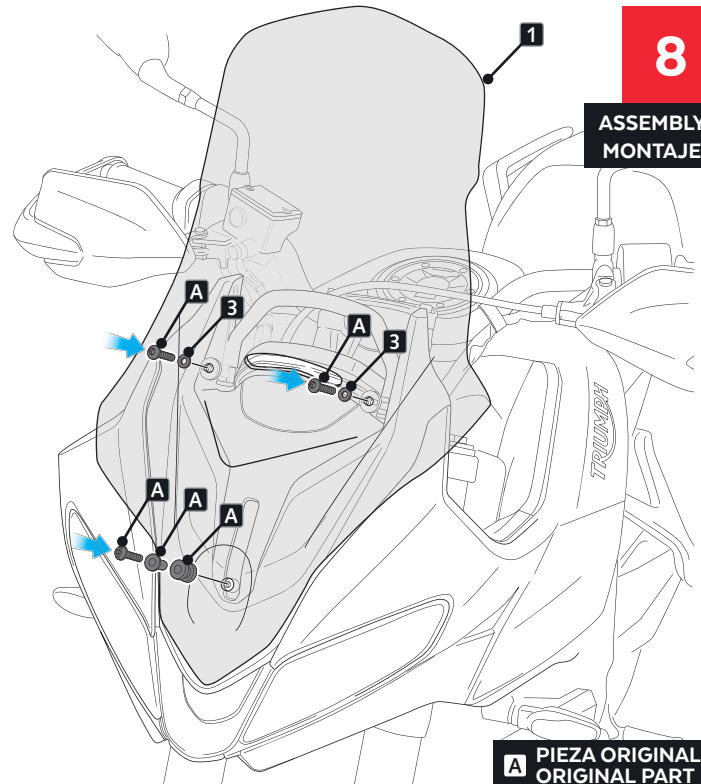

**A** PIEZA ORIGINAL  
ORIGINAL PART

# 2.0 MULTI-ADJUSTABLE VISOR ( FIX )

## M O U N T I N G I N S T R U C T I O N S

REF 20763

UNIVERSAL ( FIXED VERSION )



1 Person

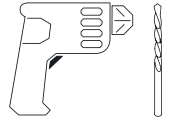

Ø7



15 min



PHILLIPS  
SCREWDRIVER



EASY

ALLEN  
Nº 4



ID	PIEZA/PART	DESCRIPCIÓN	DESCRIPTION	QTY	REF
1		Visera de policarbonato antirayadas	Antiscratch polycarbonate Visor	1	20765H/WM3
2		Plantilla	Template	1	PLANTILLA-VISOR
3		Mecanismo Izquierdo	Left Mechanism	1	See exploding page 2
4		Mecanismo Derecho	Right Mechanism	1	See exploding page 2

# 2.0 MULTI-ADJUSTABLE VISOR ( FIX )

INSTRUCCIONES DE MONTAJE - MOUNTING INSTRUCTIONS - MONTAGEANLEITUNG

1

EXPLOTING

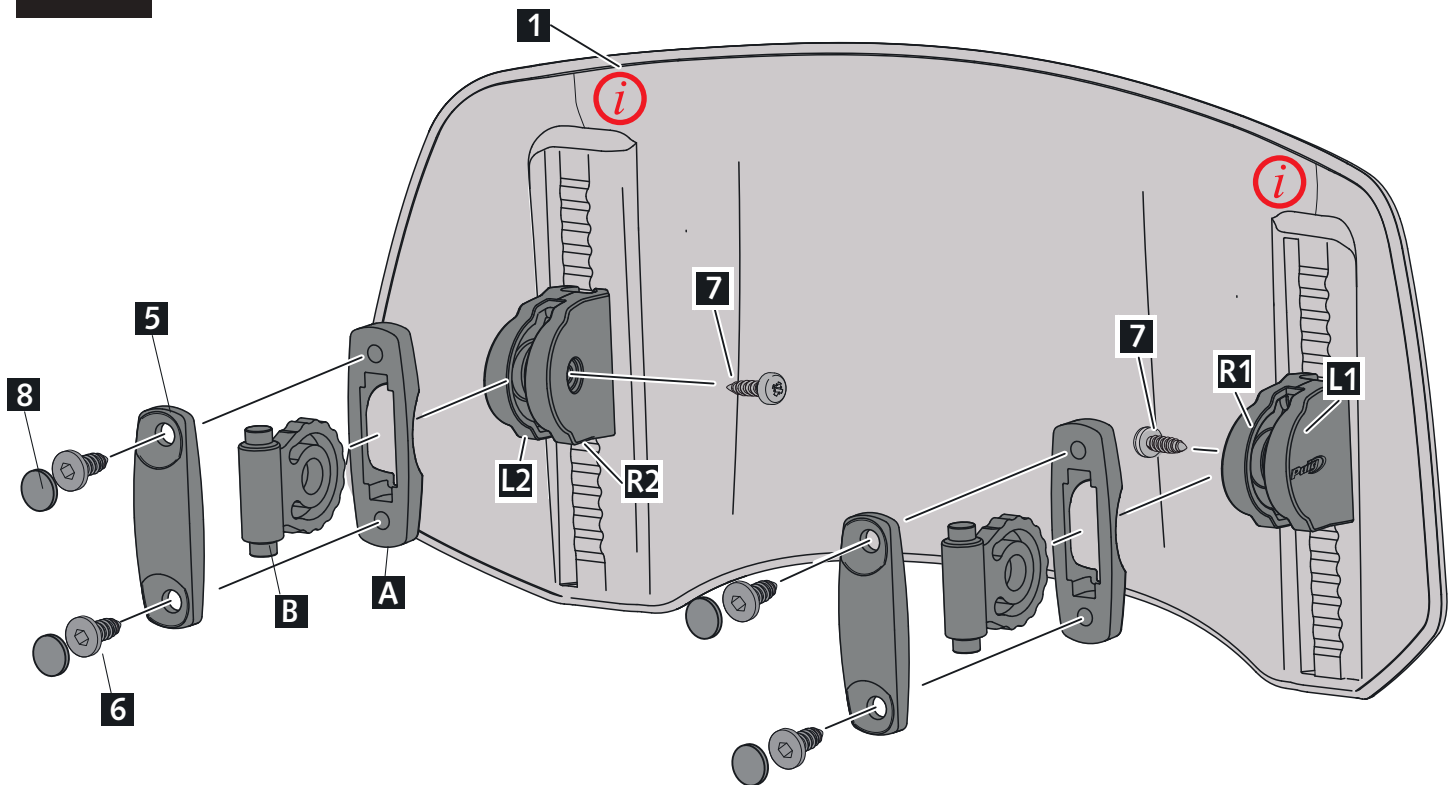

**i** LINEA DE PARTICIÓN DEL MOLDE DE INYECCIÓN. PARTING LINE OF THE INJECTION MOLD **i**

ID	PIEZA/PART	DESCRIPCIÓN	DESCRIPTION	QTY	REF
A		Tapa pieza eje	Axle part cover	2	TAPAEJE-VISOR--
B		Pieza eje	Axle part	2	EJE-FIX-VISOR--
L2		Tapa 2 Logo	Logo cover 2	1	TAPALAT-VISORL2
R2		Tapa 2 Tornillo	Screw cover 2	1	TAPALAT-VISORR2
L1		Tapa 1 Logo	Logo cover 1	1	TAPALAT-VISORL1
R1		Tapa 1 Tornillo	Screw cover 1	1	TAPALAT-VISORR1
5		Tapa cúpula	screen cover	2	TAPAFIX-VISOR--
6		Tornillo allen S.T. 6,3 x14	S.T. 6,3 x14 Allen screw	4	TOZN00M60000258
7		Tornillo Ø3,5x9,5 DIN7981 F	Ø3,5x9.5 DIN7981F screw	2	TORNI-D7981-885
8		Tapón tornillo M6	M6 Screw cap	4	TAPON-----81

## 2.0 MULTI-ADJUSTABLE VISOR ( FIX)

INSTRUCCIONES DE MONTAJE - MOUNTING INSTRUCTIONS - MONTAGEANLEITUNG

2

ASSEMBLY  
MONTAJE

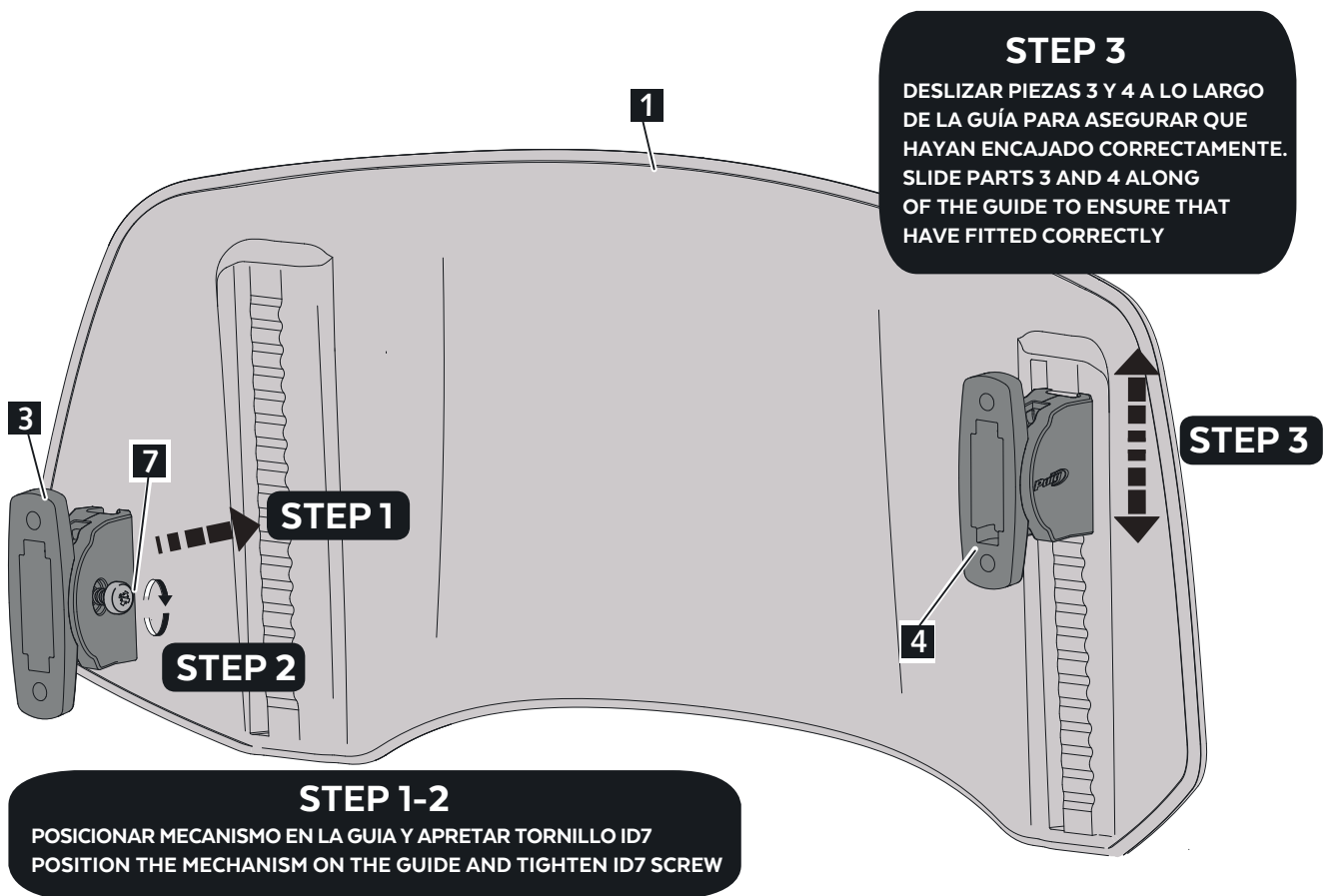

PAR APRIETE TORNILLO ID7 0,6 Nm  
TIGHTENING TORQUE FOR ID7 SCREWS 0,6 Nm

# 2.0 MULTI-ADJUSTABLE VISOR (FIX)

INSTRUCCIONES DE MONTAJE - MOUNTING INSTRUCTIONS - MONTAGEANLEITUNG

**3**

SCREEN TYPE “ ——— ”

ASSEMBLY  
MONTAJE

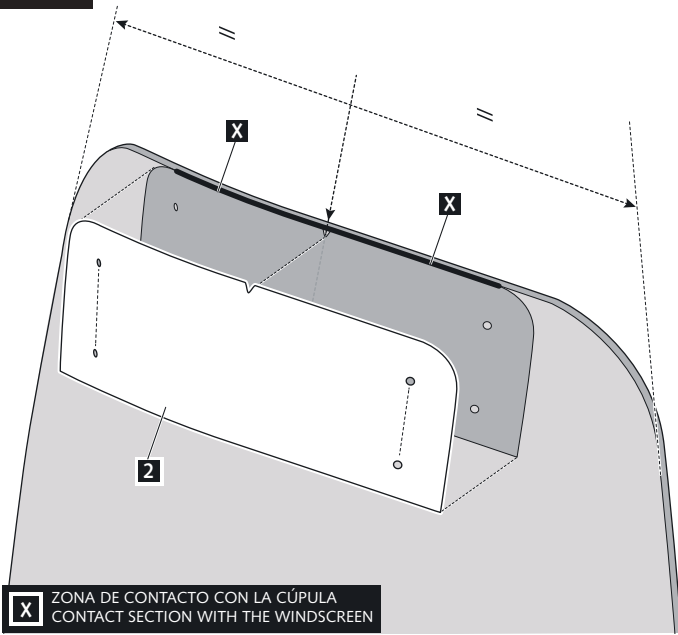

SCREEN TYPE “ ——— ”

**3**

ASSEMBLY  
MONTAJE

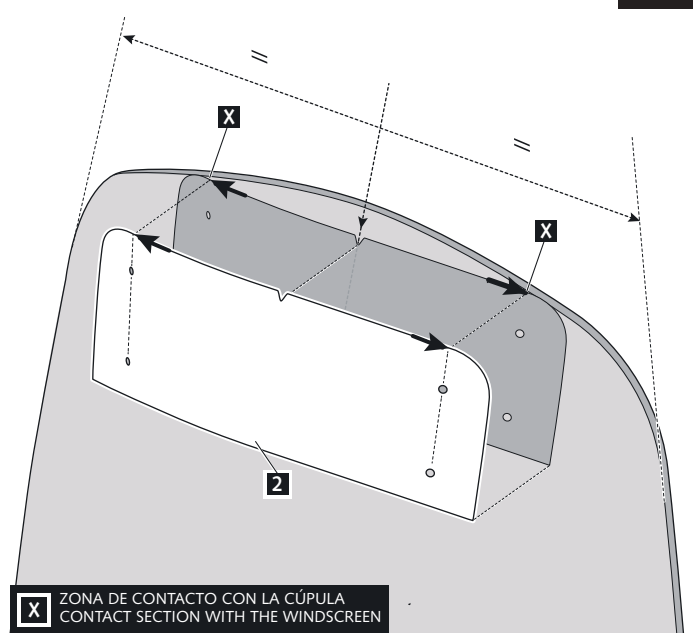

**3**

SCREEN TYPE “ ——— ”

ASSEMBLY  
MONTAJE

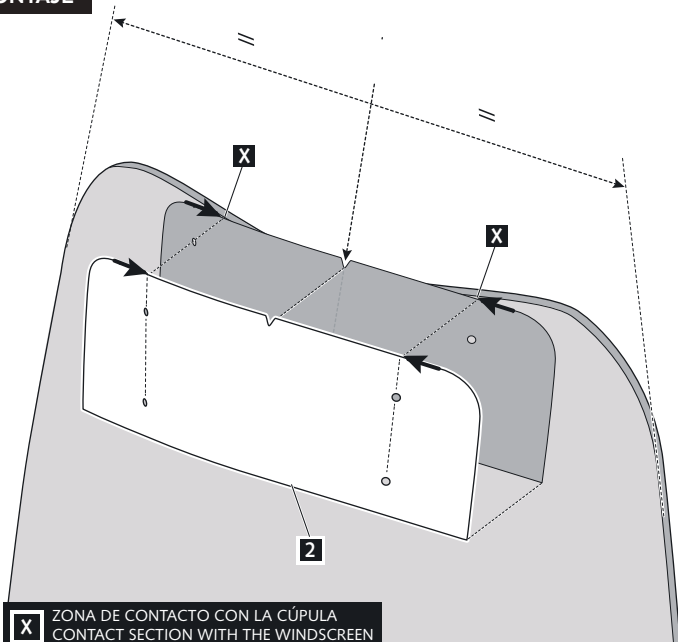

**4**

ASSEMBLY  
MONTAJE

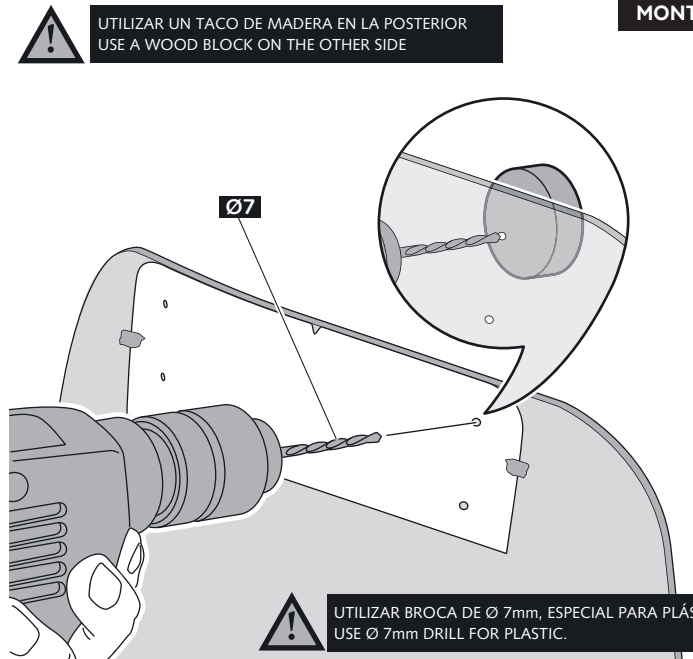

## 2.0 MULTI-ADJUSTABLE VISOR ( FIX)

INSTRUCCIONES DE MONTAJE - MOUNTING INSTRUCTIONS - MONTAGEANLEITUNG

5

ASSEMBLY  
MONTAJE

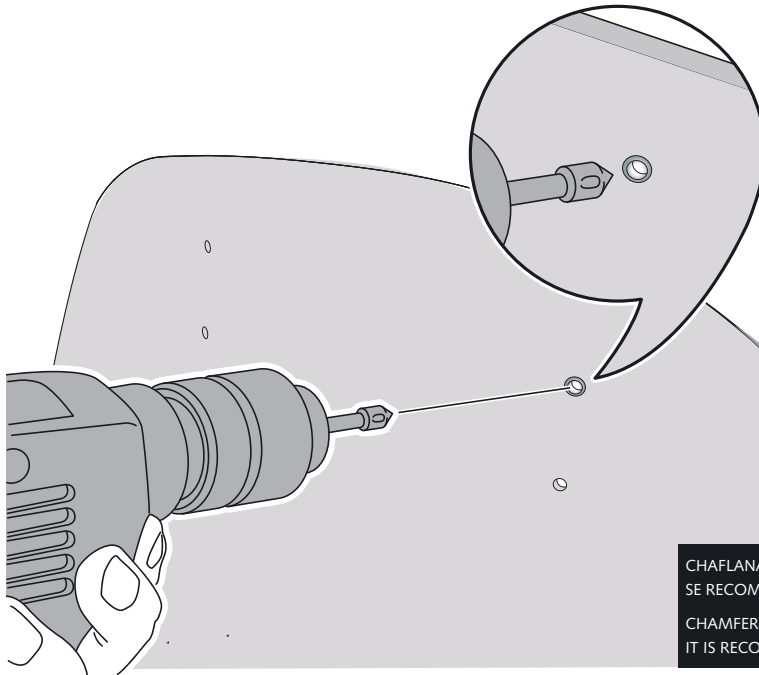

CHAFLANAR LOS 4 AGUJEROS POR AMBOS LADOS.  
SE RECOMIENDA REALIZAR CHAFLAN  $\varnothing 10\text{mm} - \varnothing 20\text{mm}$   
CHAMFER THE FOUR HOLES ON BOTH SIDES.  
IT IS RECOMMENDED TO MAKE CHAMFER  $\varnothing 10\text{mm} - \varnothing 20\text{mm}$

6

ASSEMBLY  
MONTAJE

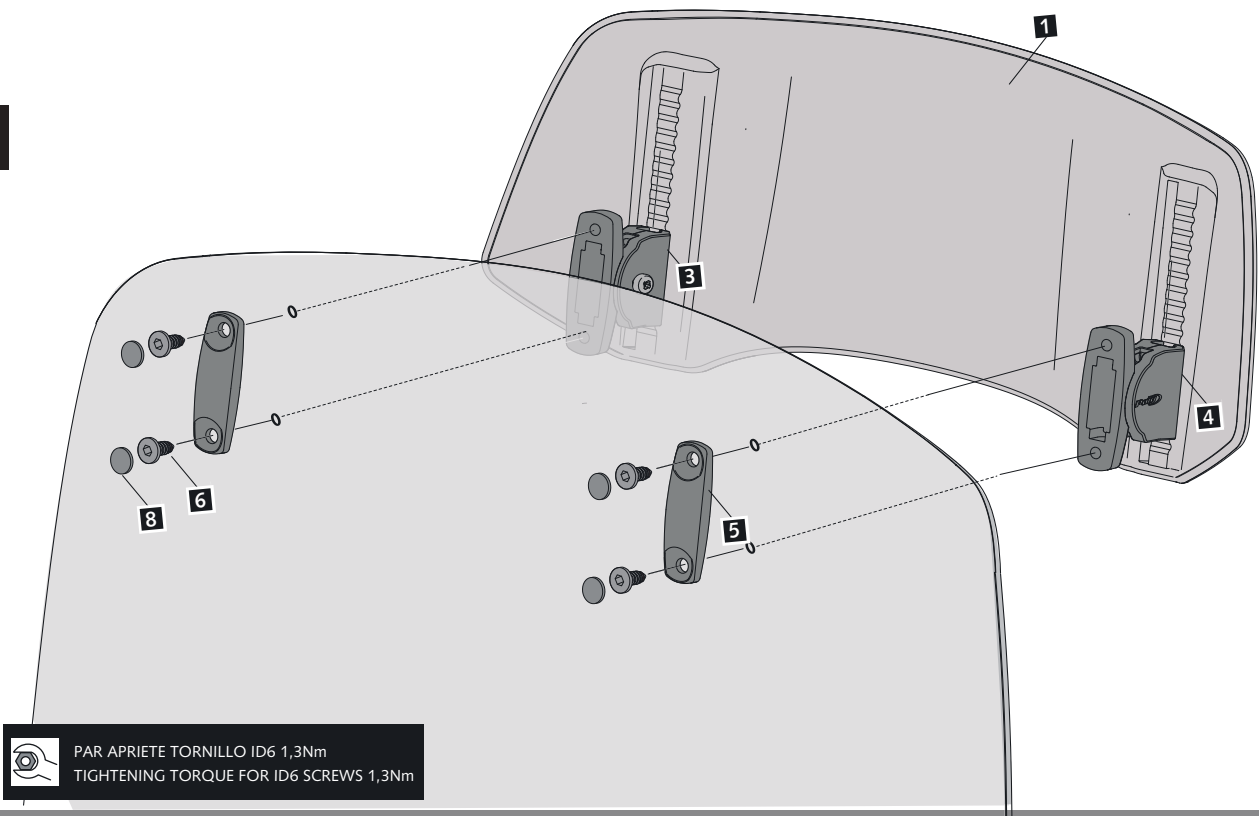

PAR APRIETE TORNILLO ID6 1,3Nm  
TIGHTENING TORQUE FOR ID6 SCREWS 1,3Nm