

HONDA CRF1100L AFRICA TWIN '20-

M O U N T I N G I N S T R U C T I O N S

REF 21397

SPORT SCREEN



1 Person



20 min











EASY

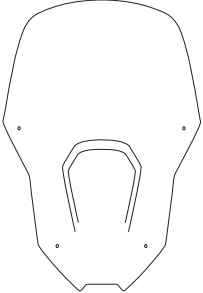
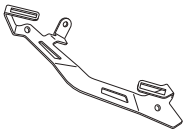
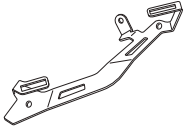

ALLEN

Nº 3
Nº 5



ID	PIEZA/PART	DESCRIPCIÓN	DESCRIPTION	QTY	REF
1		Cúpula SPORT	SPORT screen	1	3820W/H/N/FM3
2		Soporte izquierdo	Left support	1	SOPOR2P9-L-3818
3		Soporte derecho	Right support	1	SOPOR2P9-R-3818
4		Tuerca enjaulada de aluminio M5 (se suministra montada)	M5 Lock nut (supplied munted)	4	TUERCAJFM5-408
5		Casquillo Ø8,5x Ø13x 9	Ø8,5x Ø13x 9 spacer	2	CASQUI-----777
6		Tornillo Allen M5x20 Ø11 ISO 7380	M5x20 Ø11 ISO 7380 Allen screw	2	TORNI-I7380-730
7		Tornillo Allen M5x16 Ø11 ISO 7380	M5x16 Ø11 ISO 7380 Allen screw	8	TORNI-I7380-493
8		Tapón tornillo M5 ISO 7380	M5 ISO 7380 screw cap	10	TAPON-----85
9		Silentblock Ø9 xØ6 x8mm	Ø9 xØ6 x8mm silentblock	4	AROPASACABLES-3
10		Casquillo con valona Ø12xØ6,8x7,3	Ø12xØ6,8x7,3 Bush with flange	4	CASQUI-1A---750

HONDA CRF1100L AFRICA TWIN '20-

INSTRUCCIONES DE MONTAJE - MOUNTING INSTRUCTIONS - MONTAGEANLEITUNG

1

DISASSEMBLY
DESMONTAJE

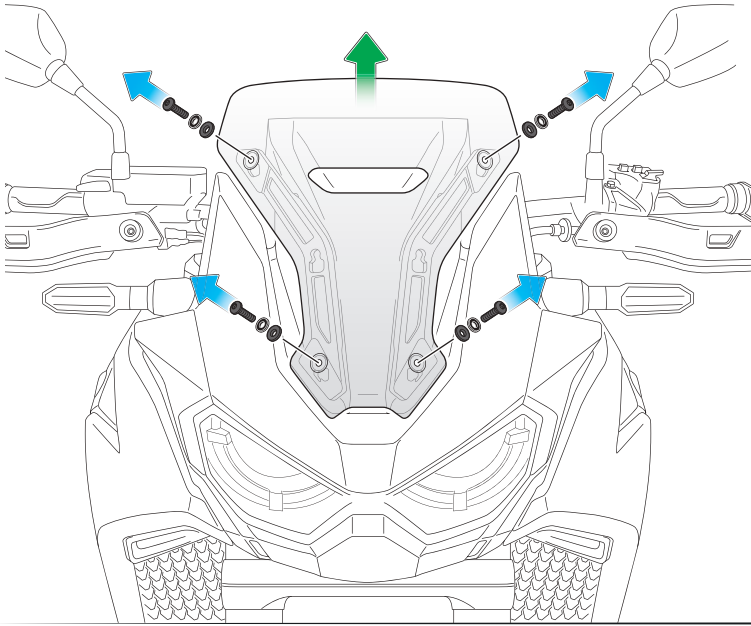

2

DISASSEMBLY
DESMONTAJE

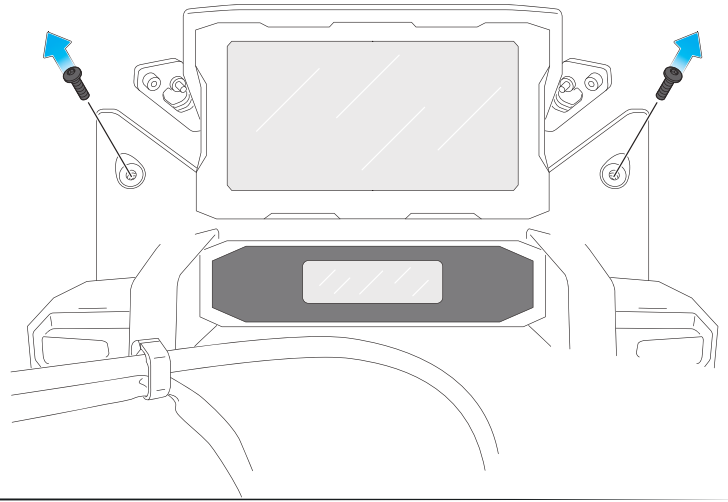

3

ASSEMBLY
MONTAJE

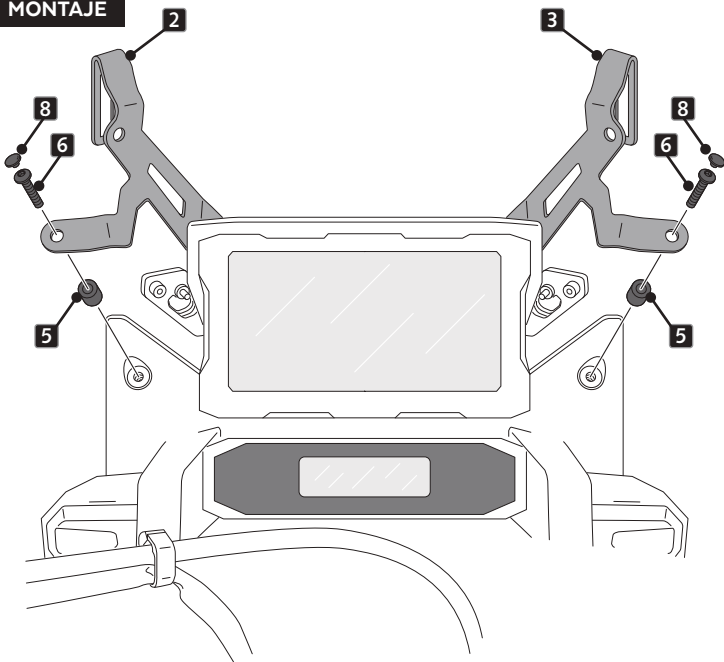

4

ASSEMBLY
MONTAJE

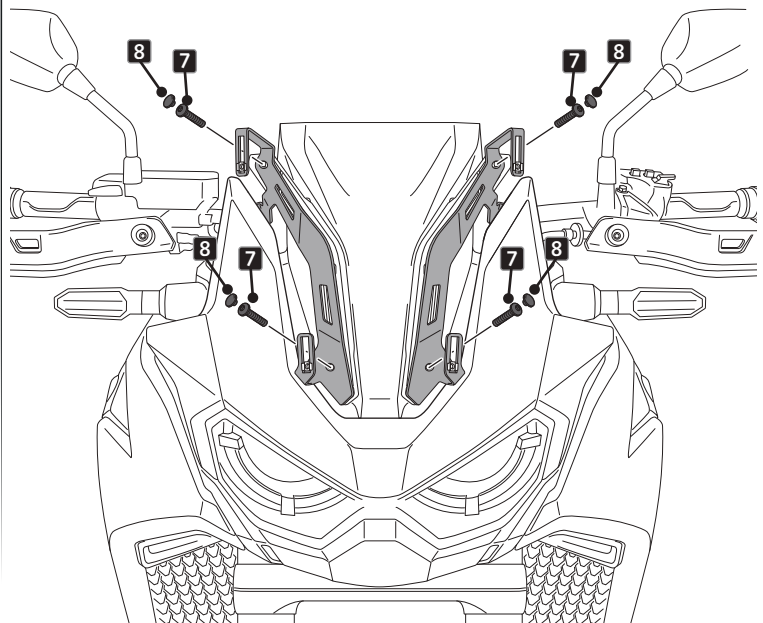

HONDA CRF1100L AFRICA TWIN '20-

INSTRUCCIONES DE MONTAJE - MOUNTING INSTRUCTIONS - MONTAGEANLEITUNG

5

ASSEMBLY
MONTAJE

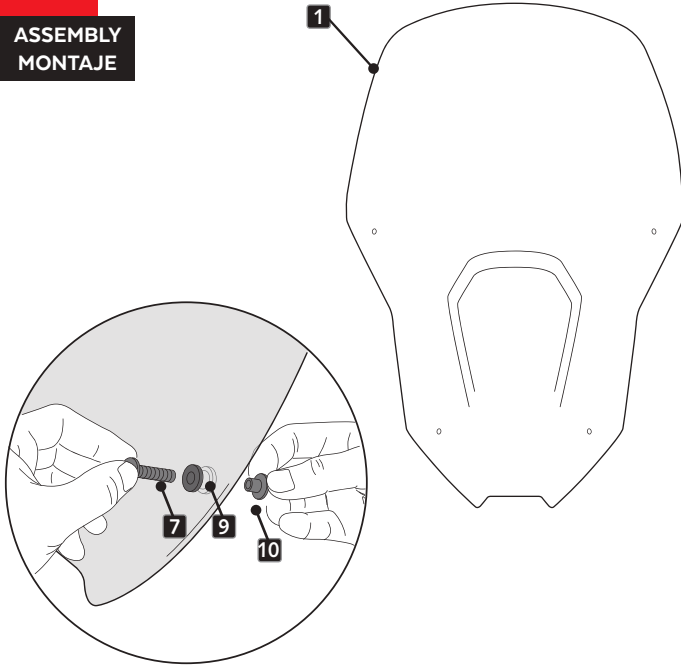

6

ASSEMBLY
MONTAJE

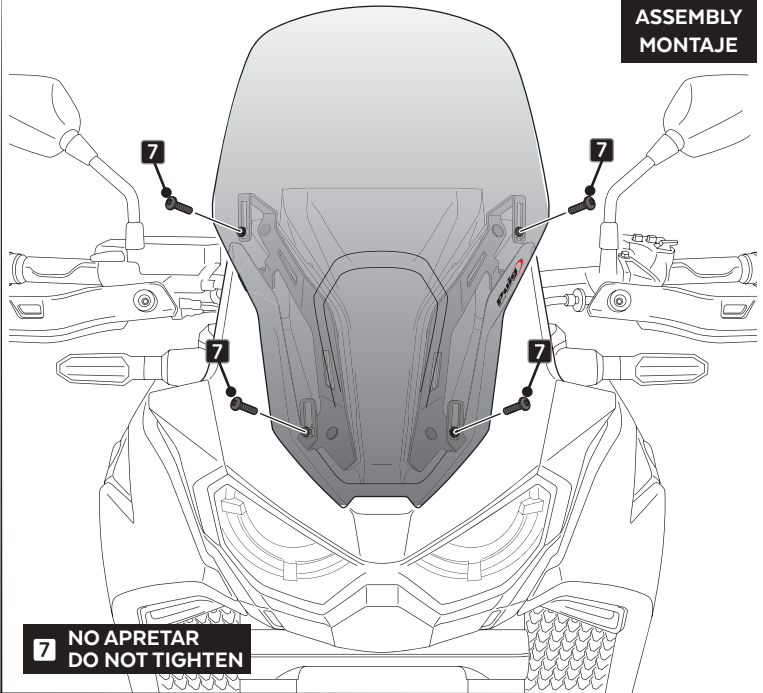

7

ASSEMBLY
MONTAJE

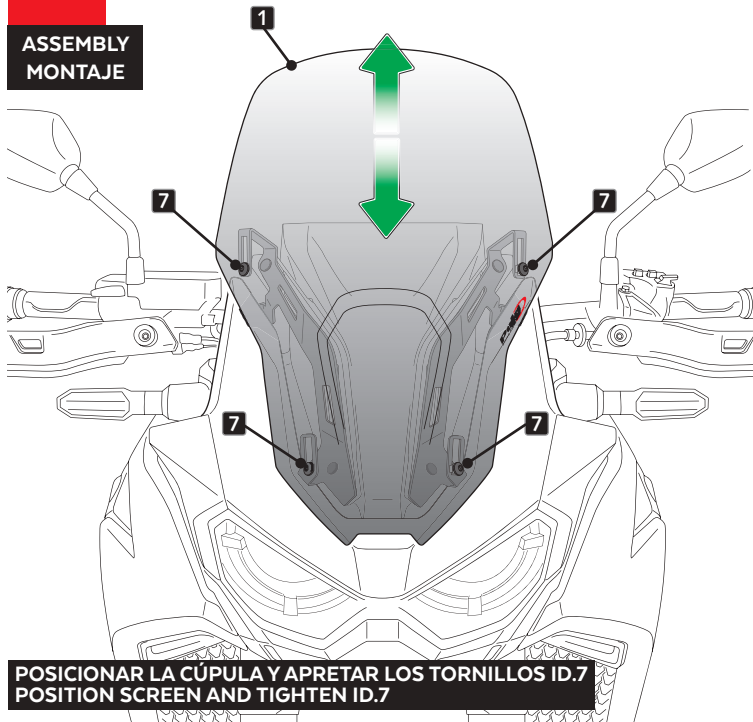

8

ASSEMBLY
MONTAJE

