

HARLEY DAVIDSON SOFTAIL STREET BOB FXBB '21-

M O U N T I N G I N S T R U C T I O N S

REF 21213

SEMIFAIRING DARKNIGHT



TORX
T45

ALLEN
Nº 3



En las revisiones del vehículo es conveniente efectuar también el mantenimiento de apriete de toda la tornillería del semicarenado, especialmente los tornillos que fijan éste al vehículo. **Gracias por su atención.**
It would be convenient to retight the semifairing screws, specially the ones that are fixed to the motorcycle, whenever you maintain the vehicle. **Thanks for your attention.**

ID	PIEZA/PART	DESCRIPCIÓN	DESCRIPTION	QTY	REF
1		Semicarenado Dark Night	Dark Night semifairing	1	10903N
2		Cúpula	Screen	1	10904H/FM3
3		Soporte izquierdo superior (·)	Upper left support (·)	1	SOPOR4P4SL21213
4		Soporte derecho superior (·)	Upper right support (·)	1	SOPOR4P4SR21213
5		Soporte izquierdo inferior (·)	Lower left support (·)	1	SOPOR4P4IL21213
6		Soporte derecho inferior (·)	Lower right support (·)	1	SOPOR4P4IR21213
7		Tornillo Allen ANSIB 18.3 CLASE 12.9 UNC 5/16"x46	ANSIB 18.3 CLASE 12.9 UNC 5/16"x46 Allen screw	4	TORNI-ANSIB-894
8		Casquillo Ø8,5x Ø13x 15	Ø8,5x Ø13x 15 Bush	4	CASQUI-M----614
9		Silentblock M5	M5 silentblock	7	SILENBTM5-046/1
10		Arandela nylon M5x1	M5x1 nylon washer	7	ARNV00000000245
11		Tornillo Allen M5x16 Ø11 ISO 7380	M5x16 Ø11 ISO 7380 Allen screw	11	TORNI-I7380-493
12		Tapón tornillo M5 ISO 7380	M5 ISO 7380 screw cap	11	TAPON-----85
13		Silentblock Ø12xØ6x9	Ø12xØ6x9 silentblock	4	AROPASACABLES-1
14		Casquillo con valona Ø12xØ6,8x7,3	Ø12xØ6,8x7,3 Bush with flange	4	CASQUI-1A---750

HARLEY DAVIDSON SOFTAIL STREET BOB FXBB '21-

INSTRUCCIONES DE MONTAJE - MOUNTING INSTRUCTIONS - MONTAGEANLEITUNG

1

DISASSEMBLY
DESMONTAJE

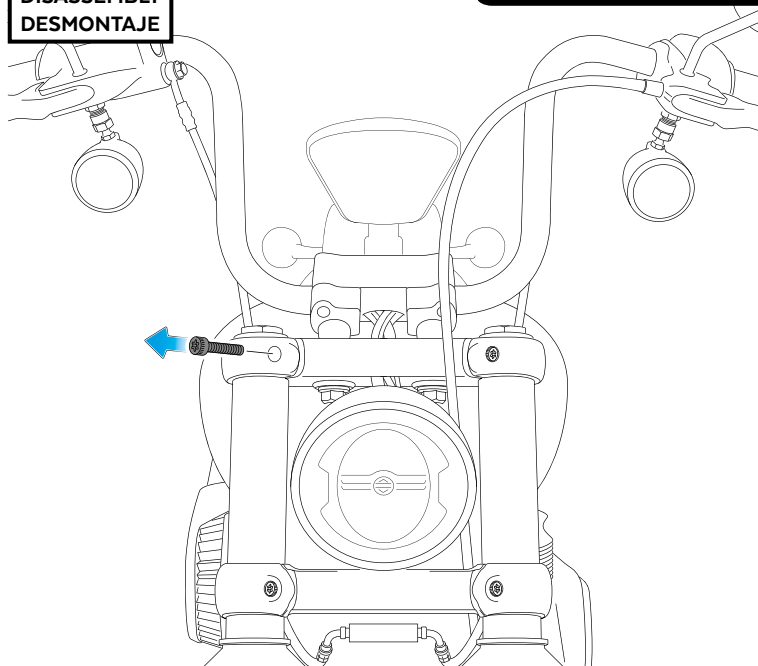

- NO EXTRAER LOS TORNILLOS A LA VEZ.
REALIZAR EL MONTAJE DE LOS SOPORTES UNO POR UNO.
- DO NOT REMOVE THE SCREWS AT THE SAME TIME
MOUNT THE SUPPORTS ONE BY ONE.

2

ASSEMBLY
MONTAJE

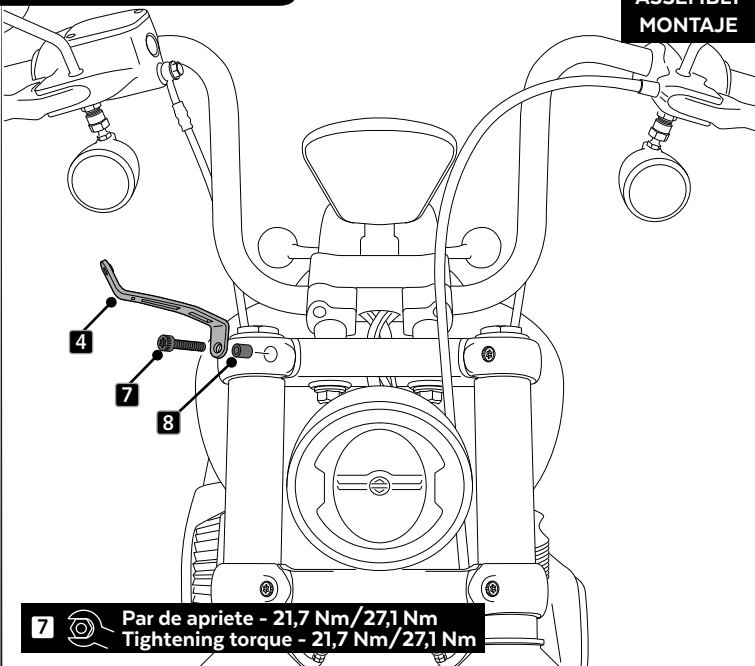

7 Par de apriete - 21,7 Nm/27,1 Nm
Tightening torque - 21,7 Nm/27,1 Nm

3

DISASSEMBLY
DESMONTAJE

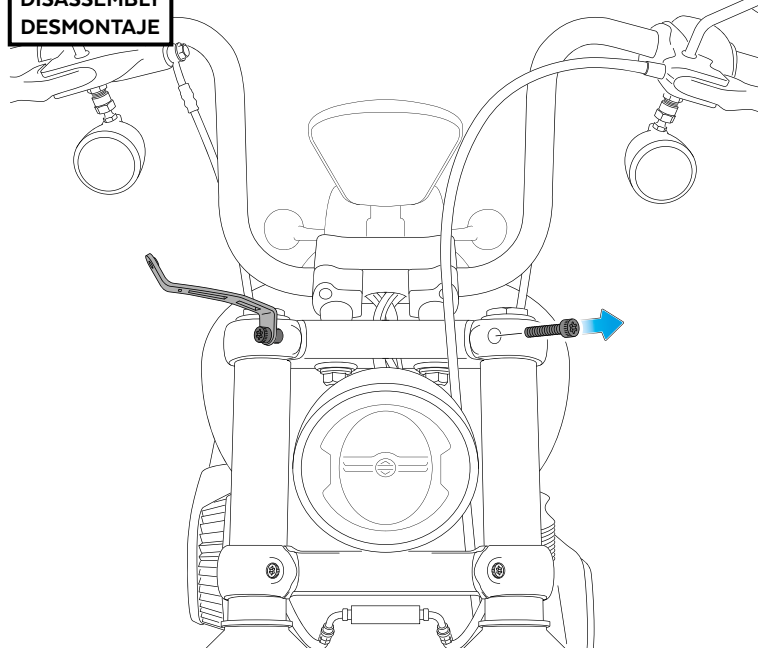

4

ASSEMBLY
MONTAJE

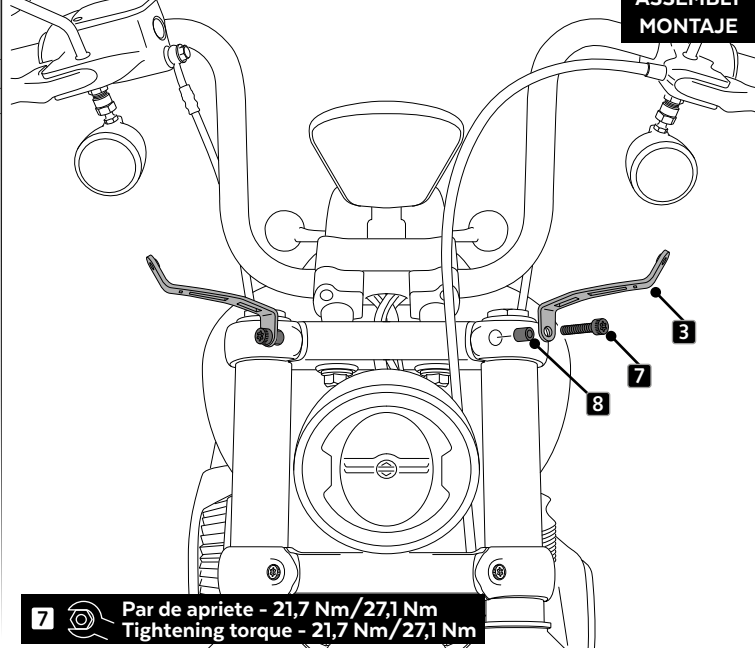

7 Par de apriete - 21,7 Nm/27,1 Nm
Tightening torque - 21,7 Nm/27,1 Nm

HARLEY DAVIDSON SOFTAIL STREET BOB FXBB '21-

INSTRUCCIONES DE MONTAJE - MOUNTING INSTRUCTIONS - MONTAGEANLEITUNG

5

DISASSEMBLY
DESMONTAJE

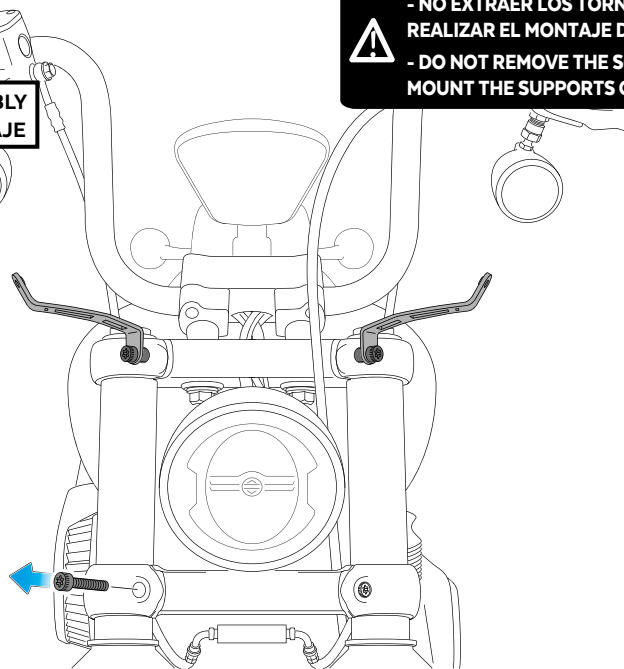

- NO EXTRAER LOS TORNILLOS A LA VEZ.
REALIZAR EL MONTAJE DE LOS SOPORTES UNO POR UNO.
- DO NOT REMOVE THE SCREWS AT THE SAME TIME
MOUNT THE SUPPORTS ONE BY ONE.

6

ASSEMBLY
MONTAJE

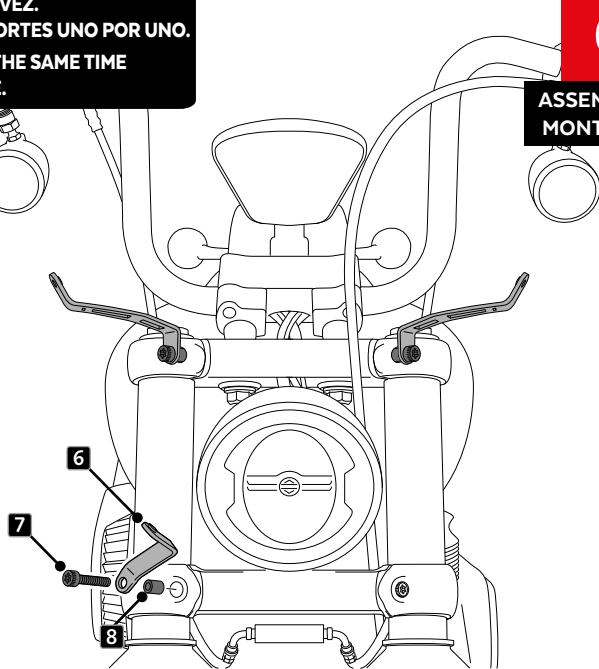

7



Par de apriete - 21,7 Nm/27,1 Nm
Tightening torque - 21,7 Nm/27,1 Nm

7

DISASSEMBLY
DESMONTAJE

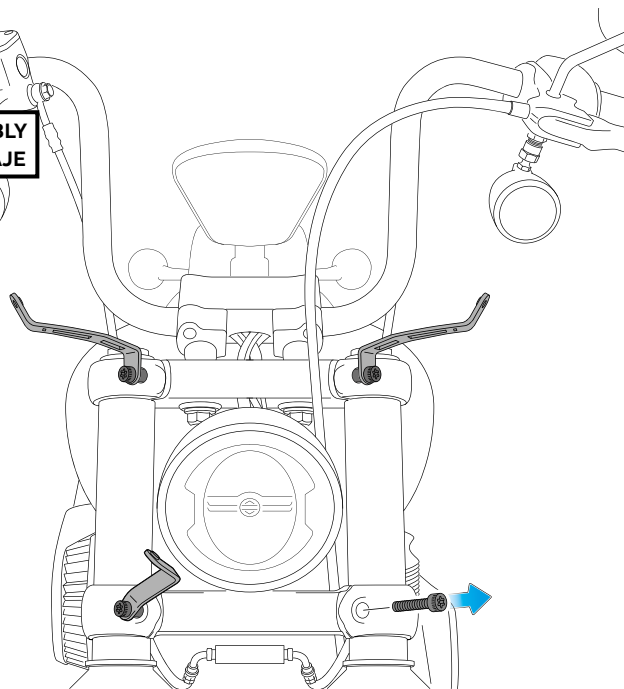

8

ASSEMBLY
MONTAJE

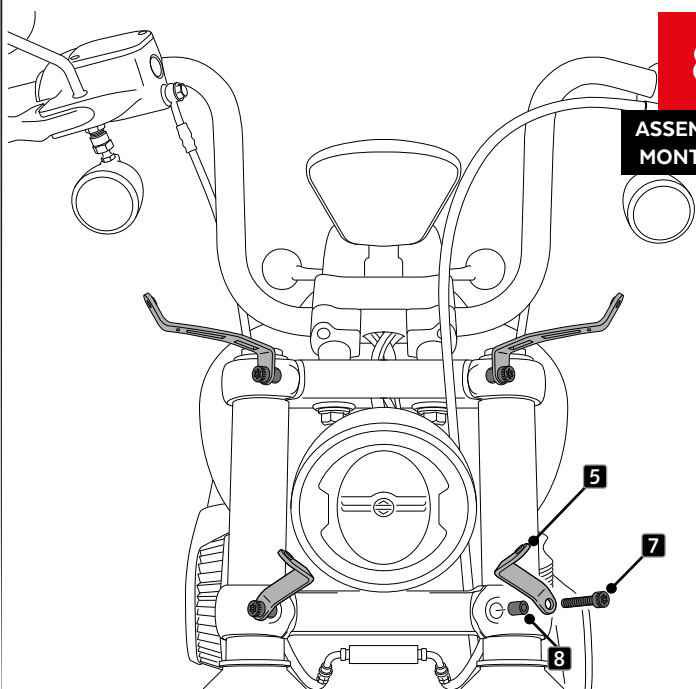

7



Par de apriete - 21,7 Nm/27,1 Nm
Tightening torque - 21,7 Nm/27,1 Nm

HARLEY DAVIDSON SOFTAIL STREET BOB FXBB '21-

INSTRUCCIONES DE MONTAJE - MOUNTING INSTRUCTIONS - MONTAGEANLEITUNG

9

ASSEMBLY
MONTAJE

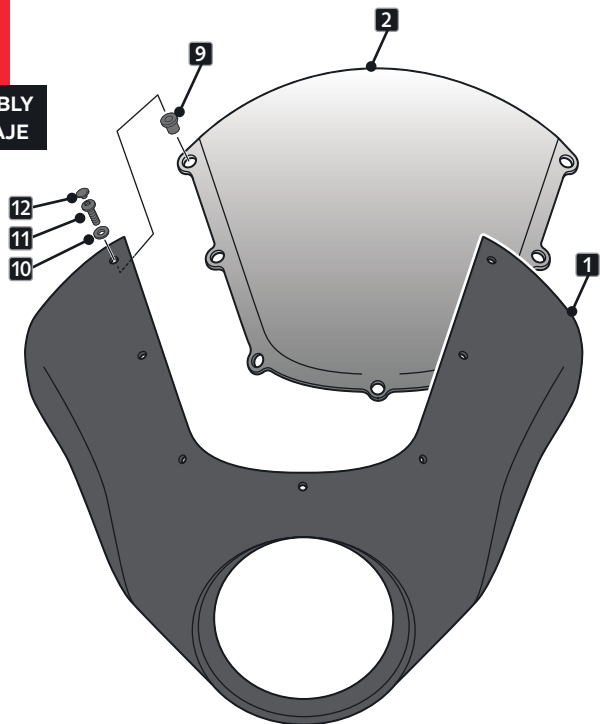

10

ASSEMBLY
MONTAJE

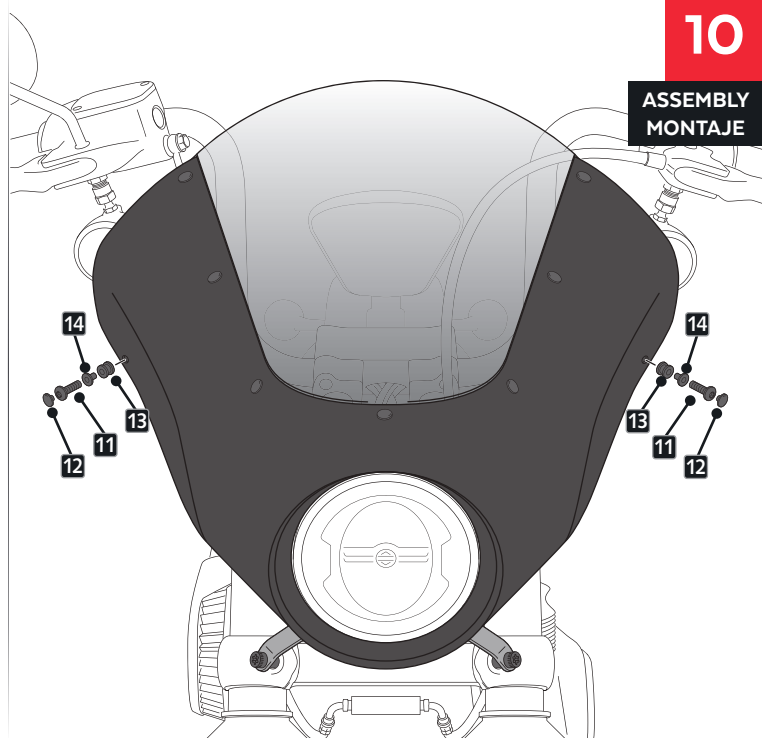

11

ASSEMBLY
MONTAJE

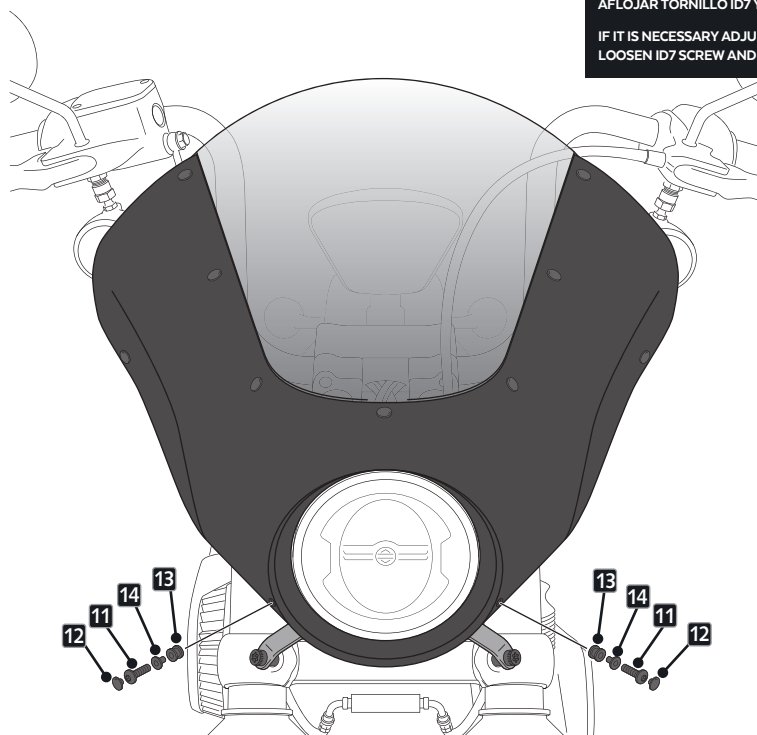

SI ES NECESARIO AJUSTAR LA POSICIÓN DEL SEMICARENADO, AFLOJAR TORNILLO ID7 Y AJUSTAR LA POSICIÓN DE LOS SOPORTES, UNO POR UNO.

IF IT IS NECESSARY ADJUST THE POSITION OF THE SEMIFAIRING, LOOSEN ID7 SCREW AND ADJUST THE POSITION OF THE SUPPORTS, ONE BY ONE.

ID7



21,7 - 27,1 Nm - Par de apriete
21,7 - 27,1 Nm - Tightening torque